



INTERPUMP

FLUID SOLUTIONS 

Powered by I.M.M. Hydraulics

Fittings

2024

Fittings

Standard Tail

N Tail

Interlock Tail

Hyblast / Multispiral Tail

Low Pressure Fittings

Standard Tail

in!



001C



Swaged Ferrule (no skive)

11

001L



Swaged Ferrule (no skive)

11

0022



Swaged Ferrule (no skive)

12

012N



Swaged Ferrule

13

0001



Swaged Ferrule (skive)

14

0002



Swaged Ferrule (skive)

15



0009



Swaged Ferrule (skive)

16

004H



Swaged Ferrule (skive)

16

0SI4



Swaged Ferrule (skive)

17

BMC1



Swaged Ferrule (no skive)

17

BMC2



Swaged Ferrule (no skive)

18



0007



Swaged Ferrule (no skive)

18

0008



Swaged Ferrule (no skive)

19



0003



Swaged Ferrule (no skive)

19



PTFE



Ferrule for PTFE hose

20

PTFE-C



Ferrule for PTFE hose

20



0345



BSP Male Flat Seat

21

0060



BSP Female flat seat

22



0350



BSP Male Parallel 60° cone

23

035G



BSP Male Parallel 60° Cone - Rotating

24

0050



BSP Female 60° cone Thrust Wire

25

0051



BSP Female 60° Cone - Rolled Nut

25

0058



BSP Female 60° Cone Slip On Nut

25

0051D



BSP Female 60° Cone - Double Hexagon

26

0150



BSP Swept Elbow 60° Cone-Thrust wire Nut

27

0151



BSP 90° Swept Elbow 60° Cone - Rolled Nut

27

0158



BSP 90° Swept elbow 60° cone Slip On Nut

27

0250



BSP Swept Elbow 60° Cone-Thrust wire Nut

28

0251



BSP 45° Swept Elbow 60° Cone Rolled nut

28

0258



BSP 45° Swept Elbow 60° Cone Slip on nut

28

2321



BSP 90° Compact Elbow 60° Cone - Rolled nut

29

2300



BSP 90° Compact Elbow 60° Cone - Thrust wire - Welded

29

0041



BSP O'Ring Female 60° Cone-Thrust wire Nut

30

0048



BSP O'Ring Female 60° Cone - Slip on nut

30

0141



BSP O'Ring 90° Swept elbow 60° cone Rolled Nut

31

0148



BSP O'Ring 90° Swept elbow 60° cone- Slip on nut

31

0241



BSP O'Ring 45° Swept Elbow 60° Cone - Rolled nut

32

0248



BSP O'Ring 45° Swept Elbow 60° Cone - Slip on nut

32



0360



BSP Taper Male 60° cone

33



0370



NPTF Male 60° cone

34

037G



NPTF Male Parallel 60°
Cone - Rotating

35

N051



NPSM Female 60° Cone
Rolled Nut

35



0850



JIC Male 74° cone

36

0900



JIC Female 74° - Thrust
Wire Nut

37

0901



JIC Female 74° cone -
Rolled Nut

37

0902



JIC Female 74° - Slip on
nut

37

0901D



JIC Female 74° Cone-
Double Hexagon

38

0950



JIC 90° Swept Elbow 74°
Cone - Thrust Wire

39

0951



JIC 90° Swept Elbow 74°
cone - Rolled Nut

39

0952



JIC 90° Swept Elbow 74°
cone - Slip on nut

39

1000



JIC 45° Swept Elbow 74°
Cone Thrust Wire Nut

40

1001



JIC 45° Swept Elbow 74°
cone - Rolled Nut

40

1002



JIC 45° Swept Elbow 74°
Cone Slip on nut

40

095S



JIC 90° Swept Elbow 74°
cone - ISO SHORT

41

2971



JIC 90° Compact Elbow
74° cone - Crimped Nut

41



0385



SAE Male O'R Flat Seat

42



0500



Metric Male 24° Seat
Light

43

0085



Metric Female 24° Seat
Light

44

0185



90° Metric Swept Elbow
24° Seat Light

45

0285



45° Metric Swept Elbow
24° Seat Light

46



0450



Metric Male 24° Seat
Heavy

47

0084



Metric Female 24° Seat
Heavy

48

0184



90° Metric Swept Elbow
24° Seat Heavy

49

0284



45° Metric Swept Elbow
24° Seat Heavy

50



0550



Metric Standpipe

51

0650



90° Metric Standpipe

52

0650S



Female Metric Tubular
90° (welded)

52

0750



45° Metric Standpipe

53

0750S



45° Metric Standpipe
(welded)

53



0035



Metric Female 24° Seat
Light Multiseal

54

0135



90° Metric Swept Elbow
24° Seat Light Multiseal

55



0400



Metric Male 60° cone

56

0100



Metric Female 60° cone

57

0200



90° Metric Swept Elbow
60° cone

58



S350



ORFS Male

59

S050



ORFS Female

60

S05T



ORFS Female Back
Hexagon

61

S150



ORFS 90° Swept Elbow

62

S15S



ORFS 90° Swept Elbow -
ISO SHORT

63

S250



ORFS 45° Swept Elbow

64



1260



Straight SAE Flange
3000 PSI

65

1060



90° SAE Flange 3000 PSI

66

1160



45° SAE Flange 3000 PSI

67

FS3L



90° SAE Flange 3000 Psi
- Long Drop

67

S003



Cut Split Flanges - 3000
psi

68



1310



Straight SAE Flange
6000 PSI

69

1110



90° SAE Flange 6000 PSI

70

1210



45° SAE Flange 6000 PSI

71

FS6L



90° SAE Flange 6000 PSI
- Long Drop

71

S006



Cut Split Flanges - 6000
psi

72



130S



Straight 'CAT' Flange

72

110S



90° 'CAT' Flange

73

120S



45° 'CAT' Flange

73



1250



Flangia Komatsu dritta
SAE 3000 PSI

74

1050



Komatsu Flange 90°

74

1150



Flangia Komatsu 45° SAE
3000 PSI

74

0940



JIS Female 60° Cone
(Komatsu)

75

0990S



90° JIS Swept Elbow
(Komatsu) - welded

76



0930



JIS Female 60° cone
(Toyota)

76

0980S



90° JIS Swept Elbow
(Toyota) - welded

77



0920



JIS Female 60° cone
(Nissan)

77



0030



Metric Female 24° Cone
French Type

78



FK50



K' Female

78

FN50



'K' Male (for gun) -
Diameter 10

79

FN51



'K' Male (for gun) -
Diameter 11

79



1400



BSP Banjo

80

1600



Double BSP Perforated
Bolt

81

1600-00



BSP Perforated Bolt

81

1350



Metric Banjo

82

1650



Metric perforated bolt

83



D050



Hose Junction

84



GS00



Weldable Fitting

85

001C

Swaged Ferrule (no skive)

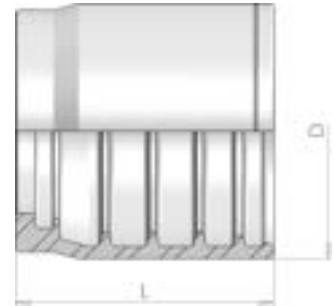

Product number	hose I.D.		Dimension		skive Length	valid for -
	in	mm	D	L		
001C-03	3/16	4.8	18.5	24	NO	R17-2SC-1SN-Pilot-H1
001C-04	1/4	6.4	20	26	NO	R17-2SC-1SC-1SN-Pilot-H1
001C-05	5/16	7.9	22	28	NO	R17-2SC-1SC-1SN-Pilot-H1
001C-06	3/8	9.5	25	28	NO	R17-2SC-1SC-1SN-Pilot-H1
001C-08	1/2	12.7	28	28	NO	R17-2SC-1SC-1SN-Pilot-H1
001C-10	5/8	15.9	32	31	NO	R17-2SC-1SC-1SN-H1
001C-12	3/4	19	36	38	NO	R17-2SC-1SC-1SN-H1
001C-16	1	25.4	44	47.5	NO	R17-2SC-1SC-1SN-H1
001C-20	1.1/4	31.8	54	56	NO	1SN-2SC-1SC
001C-24	1.1/2	38.1	61.6	66	NO	1SN-2SC-1SC
001C-32	2	50.8	75.4	73	NO	1SN-2SC-1SC
001C-40	2.1/2	63.5	88.4	80	NO	2SC-1SC
001C-48	3	76.2	100.5	90	NO	2SC-1SC

001L

Swaged Ferrule (no skive)

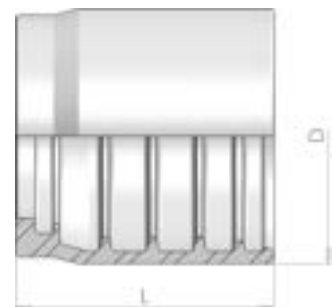

Product number	hose I.D.		Dimension		skive Length	valid for -
	in	D	L	D		
001L-04	1/4	19.2	26	NO	Hywasher 4K / HyWasher Plus 4K	
001L-05	5/16	20.6	28	NO	Hywasher 4K / HyWasher Plus 4K	
001L-06	3/8	23.3	28	NO	Hywasher 4K / HyWasher Plus 4K	
001L-08	1/2	27	28	NO	Hywasher 4K / HyWasher Plus 4K	

0022

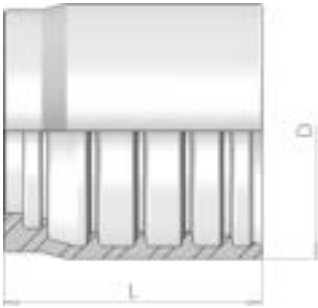

Swaged Ferrule (no skive)

Product number	hose I.D.		Dimension		skive	valid for
	in	mm	D	L	Length	-
0022-03	3/16	4.8	21	25.3	NO	2SN-(1SN)
0022-04	1/4	6.4	22	28	NO	2SN-(1SN)
0022-05	5/16	7.9	24	28	NO	2SN-(1SN)
0022-06	3/8	9.5	26	28	NO	2SN-(1SN)
0022-08	1/2	12.7	30	31	NO	2SN-(1SN)
0022-10	5/8	15.9	34	31	NO	2SN-(1SN)
0022-12	3/4	19	38	38.5	NO	2SN-(1SN)
0022-16	1	25.4	47	48	NO	2SN-(1SN)
0022-20	1.1/4	31.8	58	56	NO	2SN-(1SN)
0022-24	1.1/2	38.1	66	66	NO	2SN-(1SN)
0022-32	2	50.8	79	73	NO	2SN-(1SN)

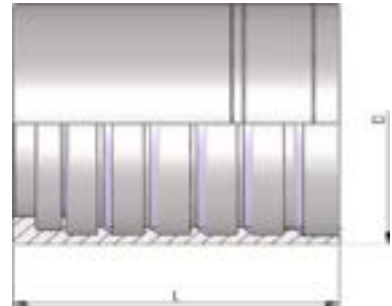
012N**Swaged Ferrule**

Product number	hose I.D.		Dimension		skive	valid for
	in	mm	D	L	Length	
012N-04	1/4	6.4	18.3	28	21	ONE 1RN-TWO 2RN-2MC-2SC
012N-05	5/16	7.9	20.0	29	22	ONE 1RN-TWO 2RN-2MC-2SC
012N-06	3/8	9.5	22.8	30	23	ONE 1RN-TWO 2RN-2MC-2SC
012N-08	1/2	12.7	26.3	32	24	ONE 1RN-TWO 2RN-2MC-2SC
012N-10	5/8	15.9	29.8	34	26	ONE 1RN-TWO 2RN-2MC-2SC
012N-12	3/4	19	34.4	40	31	ONE 1RN-TWO 2RN-2MC-2SC
012N-16	1	25.4	42.9	49	38	ONE 1RN-TWO 2RN-2MC-2SC
012N-20	1.1/4	31.8	52.5	56	43	TWO 2RN
012N-24	1.1/2	38.1	59.2	63	49	TWO 2RN
012N-32	2	50.8	72.2	73	58	TWO 2RN

0001

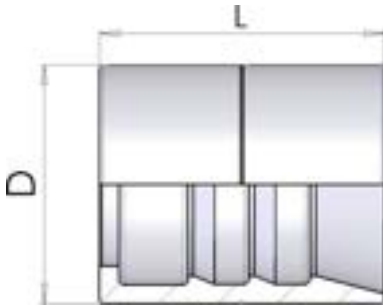

Swaged Ferrule (skive)

Product number	hose I.D.		Dimension		skive	valid for
	in	mm	D	L	Length	-
0001-03	3/16	4.8	17.5	27	20	1SN-(2SC-1ST)
0001-04	1/4	6.4	20	30.2	23	1SN-(2SC-1ST)
0001-05	5/16	7.9	22	30.7	23	1SN-(2SC-1ST)
0001-06	3/8	9.5	24	32	24	1SN-(2SC-1ST)
0001-08	1/2	12.7	28.5	34	25	1SN-(2SC-1ST)
0001-10	5/8	15.9	32	37	27	1SN-(2SC-1ST)
0001-12	3/4	19	36	43	31	1SN-(2SC-1ST)
0001-16	1	25.4	43	50	37	1SN-(2SC-1ST)
0001-20	1.1/4	31.8	52	57	46	1SN-(2SC-1ST)
0001-24	1.1/2	38.1	57	63	44	1SN-(2SC-1ST)
0001-32	2	50.8	70.6	78	60	1SN-(2SC-1ST)

0002

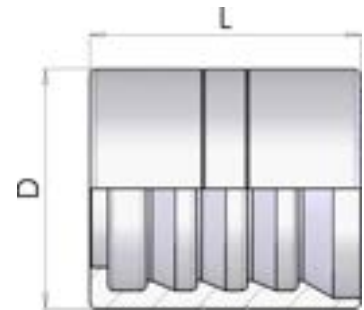
Swaged Ferrule (skive)

Product number	hose I.D.		Dimension		skive	valid for
	in	mm	D	L	Length	-
0002-03	3/16	4.8	20	27	21	2SN-(2ST)
0002-04	1/4	6.4	21	30	22	2SN-(2ST)
0002-05	5/16	7.9	24	30	22	2SN-(2ST)
0002-06	3/8	9.5	25.4	32	24	2SN-3SC-(2ST)
0002-08	1/2	12.7	30	34	25	2SN-(2ST)
0002-10	5/8	15.9	34	37	27	2SN-(2ST)
0002-12	3/4	19	38	43	31	2SN-(2ST)
0002-16	1	25.4	46	50	37	2SN-(2ST)
0002-20	1.1/4	31.8	56	59	43	2SN-(2ST)
0002-24	1.1/2	38.1	62	63	45	2SN-(2ST)
0002-32	2	50.8	75	79	61	2SN-(2ST)
0002-40	2.1/2	63.5	95	83.7	63	2SN-(2ST)
0002-48	3	76.2	105.6	94.3	78	2SN-(2ST)

0009

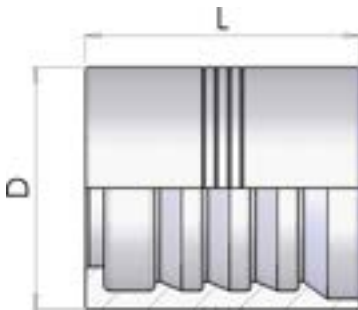

Swaged Ferrule (skive)

Product number	hose I.D.		Dimension		skive	valid for
	in	mm	D	L	Length	-
0009-04	1/4	6.4	21	30	22	4SP-R12
0009-06	3/8	9.5	25.4	33.5	26	4SP-R12
0009-08	1/2	12.7	30	36	28	4SP-R12
0009-10	5/8	15.9	34	40	31	4SP-R12
0009-12	3/4	19	38	43	34	4SP-(R12-4SH)
0009-16	1	25.4	46	60	48	(4SP-R12)
0009-20	1.1/4	31.8	56	66	54	(4SP-R12)
0009-24	1.1/2	38.1	67	76.5	62	(4SP-R12)
0009-32	2	50.8	80	79.8	64	4SP

004H

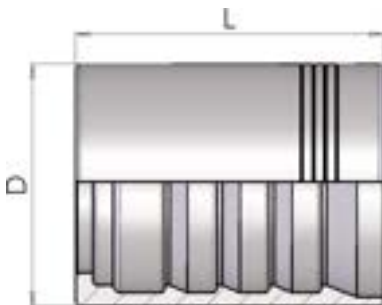

Swaged Ferrule (skive)

Product number	hose I.D.		Dimension		skive	valid for
	in	mm	D	L	Length	-
004H-20	1.1/4	31.8	52	66	55	(4SH)
004H-24	1.1/2	38.1	62	76.5	63	(4SH)

OSI4

Swaged Ferrule (skive)

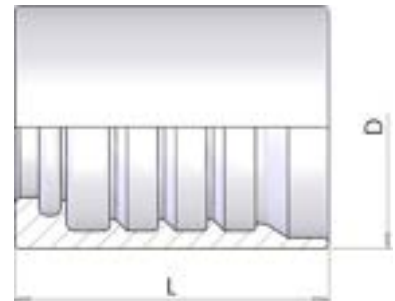

Product number	hose I.D.		Dimension		skive	valid for
	in	mm	D	L	Length	
OSI4-06	3/8	9.5	24	31	23	Four SP - Hysoflex 4K - Hysoflex 5K - Hysoflex 6K
OSI4-08	1/2	12.7	27.6	33	24.5	Four SP - Hysoflex 4K - Hysoflex 5K - Hysoflex 6K
OSI4-10	5/8	15.9	32	36	27.5	Four SP - Hysoflex 4K
OSI4-12	3/4	19	36.4	42	32.5	Four SP - Hysoflex 4K
OSI4-16	1	25.4	44	55.5	44	Four SP - Hysoflex 4K

BMC1

Swaged Ferrule (no skive)

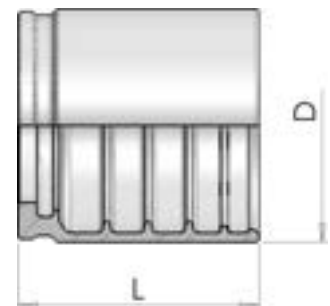

Product number	hose I.D.		Dimension		skive	valid for
	in	mm	D	L	Length	
BMC1-12	3/4	19	45	41	NO	R12
BMC1-16	1	25.4	53.5	56	NO	R12-4SP-4SH
BMC1-20	1.1/4	31.8	62	62	NO	(4SH)

BMC2

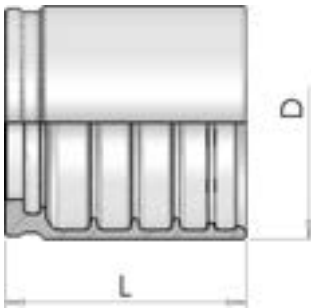

Swaged Ferrule (no skive)

Product number	hose I.D.		Dimension		skive	valid for
	in	mm	D	L	Length	-
BMC2-20	1.1/4	31.8	66	62	NO	R12-4SP
BMC2-24	1.1/2	38.1	73.3	70	NO	R12-4SP-(R13)

0007

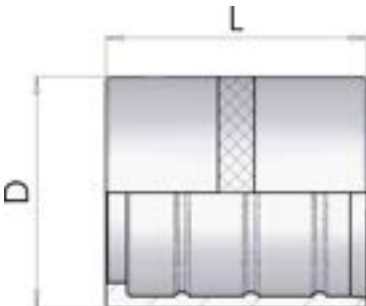

Swaged Ferrule (no skive)

Product number	hose I.D.		Dimension		skive	valid for
	in	mm	D	L	Length	-
0007-03	3/16	4.8	14	27	NO	R7-R6-1TE-2TE
0007-04	1/4	6.4	17	29	NO	R7-R6-1TE-2TE
0007-05	5/16	7.9	19	30	NO	R7-R6-1TE-2TE
0007-06	3/8	9.5	21	31	NO	R7-R6-1TE-2TE
0007-08	1/2	12.7	25.4	34	NO	R7-R6-1TE-2TE
0007-10	5/8	15.9	28.5	36	NO	R7-R6-1TE-2TE
0007-12	3/4	19	32	36	NO	R7-R6-1TE-2TE
0007-16	1	25.4	40	50	NO	R7-R6-1TE-2TE

0008

Swaged Ferrule (no skive)

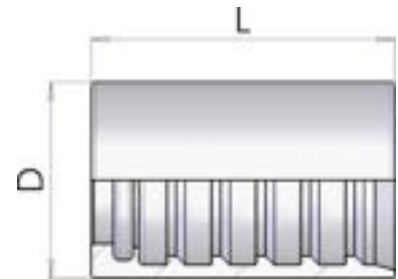

Product number	hose I.D.		Dimension		skive	valid for
	in	mm	D	L	Length	-
0008-03	3/16	4.8	13	25	NO	R8
0008-04	1/4	6.4	17	29	NO	R8
0008-05	5/16	7.9	19	30	NO	R8
0008-06	3/8	9.5	21.5	31	NO	R8
0008-08	1/2	12.7	26	34	NO	R8
0008-10	5/8	15.9	29	40	NO	R8
0008-12	3/4	19	32	42	NO	R8
0008-16	1	25.4	40	50	NO	R8

0003

Swaged Ferrule (no skive)

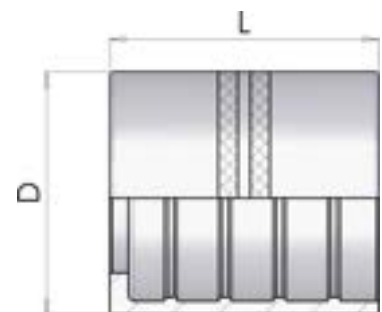

Product number	hose I.D.		Dimension		skive	valid for
	in	mm	D	L	Length	-
0003-03	3/16	4.8	14	27	NO	R3-3TE-R5
0003-04	1/4	6.4	19	29	NO	R3-3TE-R5
0003-05	5/16	7.9	22	30	NO	R3-3TE-R5
0003-06	3/8	9.5	24	31	NO	R3-3TE-R5
0003-08	1/2	12.7	28.5	34	NO	R3-3TE-R5
0003-10	5/8	15.9	32	36	NO	R3-3TE-R5
0003-12	3/4	19	38	42	NO	R3-3TE-R5
0003-16	1	25.4	46	50	NO	R3-3TE
0003-20	1.1/4	31.8	52	57	NO	R3-3TE

PTFE

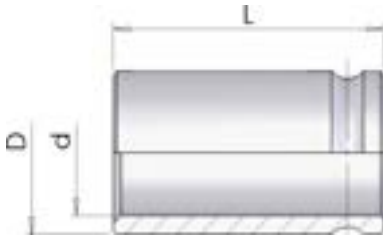

Ferrule for PTFE hose

Product number	hose I.D.		Dimension			skive	valid for
	in	mm	D	L	d-int	Length	-
PTFE-03	3/16	4.8	12.7	22	9.5	NO	PTFE type T1
PTFE-04	1/4	6.4	14.4	23.9	11.1	NO	PTFE type T1
PTFE-05	5/16	7.9	17.1	24.6	13	NO	PTFE type T1
PTFE-06	3/8	9.5	19	27.4	15	NO	PTFE type T1
PTFE-08	1/2	12.7	22.4	28.7	18.3	NO	PTFE type T1
PTFE-10	5/8	15.9	27	31.7	23.1	NO	PTFE type T1
PTFE-12	3/4	19	28.7	34.5	24.8	NO	PTFE type T1
PTFE-16	1	25.4	38.1	43.6	34.3	NO	PTFE type T1

For PTFE hose type T1 - (with standard fittings)

PTFE-C

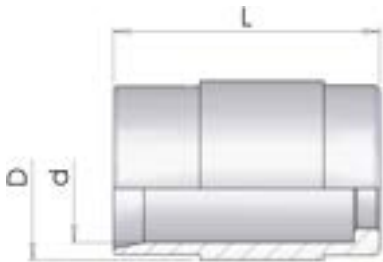

Ferrule for PTFE hose

Product number	hose I.D.		Dimension			skive	valid for
	in	mm	D	L	d-int	Length	-
PTFE-04-C	1/4	6.4	17.8	26.5	14.4	NO	PTFE type LTC
PTFE-06-C	3/8	9.5	20	30.5	16.8	NO	PTFE type LTC
PTFE-08-C	1/2	12.7	24	33.2	20.5	NO	PTFE type LTC
PTFE-10-C	5/8	15.9	29.2	34.8	25.4	NO	PTFE type LTC
PTFE-12-C	3/4	19	31.1	40.9	27.4	NO	PTFE type LTC
PTFE-16-C	1	25.4	38.5	47	34.7	NO	PTFE type LTC

For PTFE hose type LTC - (with standard fittings)

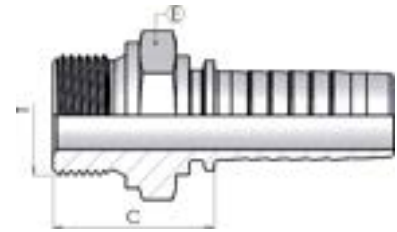
0345**BSP Male - Flat Seat****(AGR-F)**

Product number	hose I.D.		Dimension			
	in	mm	dash size	T	E	Cut-off C
0345-04-04	1/4	6.4	04	1/4-19	19	27
0345-05-06	5/16	7.9	05	3/8-19	22	28
0345-06-06	3/8	9.5	06	3/8-19	22	29
0345-06-08	3/8	9.5	06	1/2-14	27	32
0345-08-08	1/2	12.7	08	1/2-14	27	33
0345-10-12	5/8	15.9	10	3/4-14	32	35
0345-12-12	3/4	19	12	3/4-14	32	36
0345-12-16	3/4	19	12	1-11	41	39
0345-16-16	1	25.4	16	1-11	41	40

0060

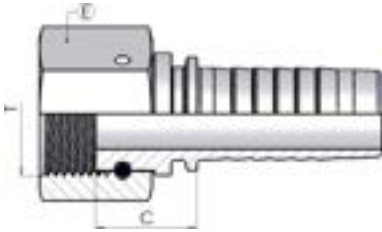

BSP Female flat seat

(DKR-F)

Product number	hose I.D.		Dimension			
	in	mm	dash size	T	E	Cut-off C
0060-04-04	1/4	6.4	04	1/4-19	19	14
0060-04-06	1/4	6.4	04	3/8-19	22	15
0060-05-06	5/16	7.9	05	3/8-19	22	15
0060-05-08	5/16	7.9	05	1/2-14	27	17
0060-06-06	3/8	9.5	06	3/8-19	22	15
0060-06-08	3/8	9.5	06	1/2-14	27	16
0060-08-08	1/2	12.7	08	1/2-14	27	16
0060-08-12	1/2	12.7	08	3/4-14	32	23
0060-10-10	5/8	15.9	10	5/8-14	30	16
0060-10-12	5/8	15.9	10	3/4-14	32	20
0060-12-12	3/4	19	12	3/4-14	32	21
0060-12-16	3/4	19	12	1-11	38	23
0060-16-16	1	25.4	16	1-11	38	22

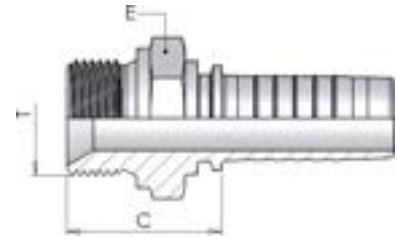
0350**BSP Male Parallel 60° cone****(AGR)**

Product number	hose I.D.		Dimension			
	in	mm	dash size	T	E	Cut-off C
0350-03-02	3/16	4.8	03	1/8-28	14	21
0350-03-04	3/16	4.8	03	1/4-19	19	26
0350-04-02	1/4	6.4	04	1/8-28	14	21
0350-04-04	1/4	6.4	04	1/4-19	19	27
0350-04-06	1/4	6.4	04	3/8-19	22	28
0350-04-08	1/4	6.4	04	1/2-14	27	35
0350-05-04	5/16	7.9	05	1/4-19	19	27
0350-05-06	5/16	7.9	05	3/8-19	22	28
0350-05-08	5/16	7.9	05	1/2-14	27	32
0350-06-04	3/8	9.5	06	1/4-19	19	27
0350-06-06	3/8	9.5	06	3/8-19	22	29
0350-06-08	3/8	9.5	06	1/2-14	27	32
0350-08-06	1/2	12.7	08	3/8-19	22	29
0350-08-08	1/2	12.7	08	1/2-14	27	33
0350-08-10	1/2	12.7	08	5/8-14	30	34
0350-08-12	1/2	12.7	08	3/4-14	32	35
0350-10-08	5/8	15.9	10	1/2-14	27	33
0350-10-10	5/8	15.9	10	5/8-14	30	35
0350-10-12	5/8	15.9	10	3/4-14	32	35
0350-12-08	3/4	19	12	1/2-14	27	33
0350-12-12	3/4	19	12	3/4-14	32	36
0350-12-16	3/4	19	12	1-11	41	39
0350-16-16	1	25.4	16	1-11	41	40
0350-16-20	1	25.4	16	1.1/4-11	50	44
0350-20-16	1.1/4	31.8	20	1-11	41	41
0350-20-20	1.1/4	31.8	20	1.1/4-11	50	45
0350-20-24	1.1/4	31.8	20	1.1/2-11	55	46
0350-24-24	1.1/2	38.1	24	1.1/2-11	55	46
0350-24-32	1.1/2	38.1	24	2-11	70	54
0350-32-24	2	50.8	32	1.1/2-11	65	50
0350-32-32	2	50.8	32	2-11	70	54

035G

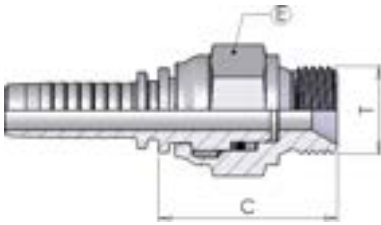

BSP Male Parallel 60° Cone - Rotating

(AGR-RO)

Product number	hose I.D.		Dimension			
	in	mm	dash size	T	E	Cut-off C
035G-04-04	1/4	6.4	04	1/4-19	19	37
035G-06-06	3/8	9.5	06	3/8-19	22	43
035G-08-08	1/2	12.7	08	1/2-14	27	47
035G-12-12	3/4	19	12	3/4-14	32	52

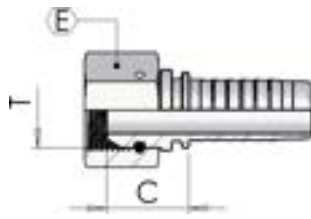
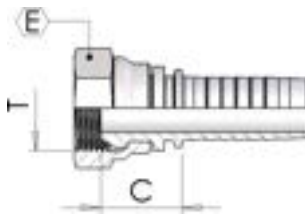
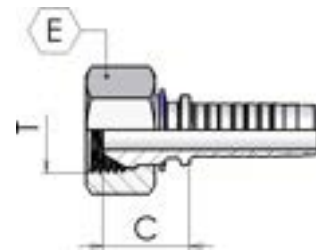
0050**0051****0058****BSP Female 60° Cone****(DKR)**

Product number	hose I.D.		Dimension			
	in	mm	dash size	T	E	Cut-off C
0051-03-02	3/16	4.8	03	1/8-28	14	15
0058-03-04	3/16	4.8	03	1/4-19	19	17
0051-04-02	1/4	6.4	04	1/8-28	14	15
0058-04-04	1/4	6.4	04	1/4-19	19	21
0058-04-06	1/4	6.4	04	3/8-19	22	21
0051-05-04	5/16	9.5	05	1/4-19	19	19
0058-05-06	5/16	7.9	05	3/8-19	22	21
0058-05-08	5/16	7.9	05	1/2-14	27	22
0051-06-04	3/8	9.5	06	1/4-19	19	17
0058-06-06	3/8	9.5	06	3/8-19	22	21
0058-06-08	3/8	9.5	06	1/2-14	27	23
0051-08-06	1/2	12.7	08	3/8-19	22	20
0058-08-08	1/2	12.7	08	1/2-14	27	23
0051-08-10	1/2	12.7	08	5/8-14	30	20
0051-08-12	1/2	12.7	08	3/4-14	32	27
0051-10-08	5/8	15.9	10	1/2-14	27	23
0051-10-10	5/8	15.9	10	5/8-14	30	20
0051-10-12	5/8	15.9	10	3/4-14	32	25
0051-12-08	3/4	19	12	1/2-14	27	24
0051-12-12	3/4	19	12	3/4-14	32	25
0051-12-16	3/4	19	12	1-11	38	26
0051-16-12	1	25.4	16	3/4-14	32	27
0051-16-16	1	25.4	16	1-11	38	27
0050-16-20*	1	25.4	16	1.1/4-11	50	30
0050-20-20*	1.1/4	31.8	20	1.1/4-11	50	32
0050-20-24*	1.1/4	31.8	20	1.1/2-11	55	34
0050-24-24*	1.1/2	38.1	24	1.1/2-11	55	34
0050-24-32*	1.1/2	38.1	24	2-11	70	34
0050-32-32*	2	50.8	32	2-11	70	31
0050-40-40	2.1/2	63.5	40	2.1/2-11	85	41
0050-48-48	3	76.2	48	3-11	100	45

0051D

BSP Female 60° Cone - Double Hexagon

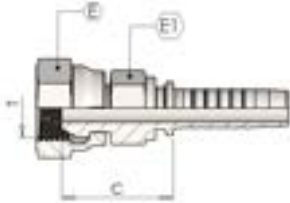

Product number	hose I.D.		Dimension				
	in	mm	dash size	T	E	E1	Cut-off C
0051D04-04	1/4	6,4	04	1/4-19	19	14	22
0051D06-06	3/8	9.5	06	3/8-19	22	17	28
0051D08-08	1/2	12.7	08	1/2-14	27	22	30
0051D12-12	3/4	19	12	3/4-14	32	27	35

0150

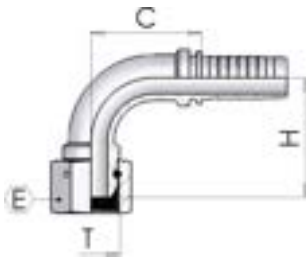

0151

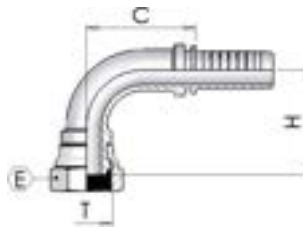

0158

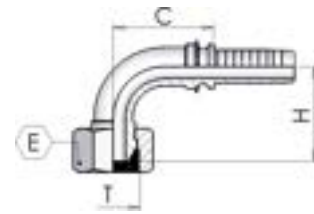

BSP 90° Swept elbow 60° cone

Product number	hose I.D.		Dimension				
	in	mm	dash size	T	E	drop H	Cut-off C
0151-03-02	3/16	03	03	1/8-28	14	23	23
0151-03-04	3/16	03	03	1/4-19	19	25	25
0151-04-02	1/4	04	04	1/8-28	14	25	25
0158-04-04	1/4	04	04	1/4-19	19	21	27
0158-04-06	1/4	04	04	3/8-19	22	24	27
0151-05-04	5/16	05	05	1/4-19	19	31	31
0158-05-06	5/16	05	05	3/8-19	22	29	31
0151-06-04	3/8	06	06	1/4-19	19	33	31
0158-06-06	3/8	06	06	3/8-19	22	29	33
0158-06-08	3/8	06	06	1/2-14	27	31	36
0151-08-06	1/2	08	08	3/8-19	22	42	39
0158-08-08	1/2	08	08	1/2-14	27	37.5	38.5
0151-08-10	1/2	08	08	5/8-14	30	41	40
0151-08-12	1/2	08	08	3/4-14	32	46	41
0151-10-10	5/8	10	10	5/8-14	30	43	43
0151-10-12	5/8	10	10	3/4-14	32	50	45
0151-12-12	3/4	12	12	3/4-14	32	57	56
0151-12-16	3/4	12	12	1-11	38	56	56
0151-16-16	1	16	16	1-11	38	67	70
0150-20-20*	1.1/4	20	20	1.1/4-11	50	84	83
0150-24-24*	1.1/2	24	24	1.1/2-11	55	95	103
0150-32-32*	2	32	32	2-11	70	124	133

(*) - On request available in version without O-Ring (in case of order use code 015X)

(*) - BSP O-Ring Female



0250

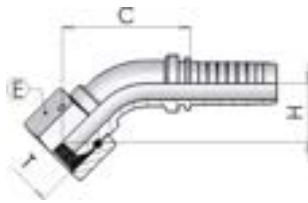

0251

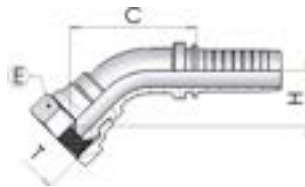

0258

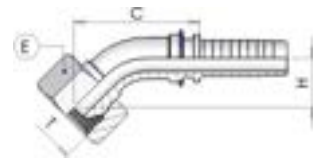

BSP 45° Swept Elbow 60° Cone

(DKR-45°)

Product number	hose I.D.		Dimension				
	in	mm	dash size	T	E	drop H	Cut-off C
0251-03-02	3/16	4.8	03	1/8-28	14	15	33
0251-04-02	1/4	6.4	04	1/8-28	14	14	40
0258-04-04	1/4	6.4	04	1/4-19	19	14	39
0258-04-06	1/4	6.4	04	3/8-19	22	16	41
0251-05-04	5/16	7.9	05	1/4-19	19	16	47
0251-06-04	3/8	9.5	06	1/4-19	19	19	50
0258-06-06	3/8	9.5	06	3/8-19	22	17	47
0258-06-08	3/8	9.5	06	1/2-14	27	16	52
0251-08-06	1/2	12.7	08	3/8-19	22	22	63
0258-08-08	1/2	12.7	08	1/2-14	27	19	61
0251-08-10	1/2	12.7	08	5/8-14	30	21	64
0251-08-12	1/2	12.7	08	3/4-14	32	26	67
0251-10-08	5/8	15.9	10	1/2-14	27	24	68
0251-10-10	5/8	15.9	10	5/8-14	30	23	68
0251-10-12	5/8	15.9	10	3/4-14	32	27	72
0251-12-12	3/4	19	12	3/4-14	32	28	88
0251-12-16	3/4	19	12	1-11	38	32	88
0251-16-16	1	25.4	16	1-11	38	30	88
0250-20-20*	1.1/4	31.8	20	1.1/4-11	50	40	107
0250-24-24*	1.1/2	38.1	24	1.1/2-11	55	51	117
0250-32-32*	2	50.8	32	2-11	70	59	146

(*) - BSP O-Ring Female

(*) - On request available in version without O-Ring (in case of order use code 025X)

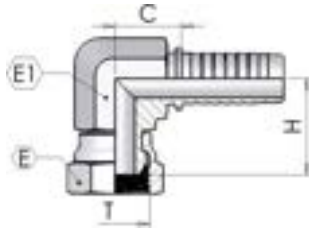
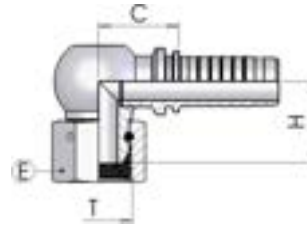

2321**2300****BSP 90° Compact Elbow 60° Cone****(DKR 90° K)**

Product number	hose I.D.		Dimension						
	in	mm	dash size	T	E	E1	drop H	Cut-off C	
2321-03-02	3/16	4.8	03	1/8-28	14	12	18	17	
2321-03-04	3/16	4.8	03	1/4-19	19	14	20	17	
2321-04-04	1/4	6.4	04	1/4-19	19	15	20	19	
2321-04-06	1/4	6.4	04	3/8-19	22	17	29	24	
2321-05-06	5/16	7.9	05	3/8-19	22	17	23	24	
2321-06-06	3/8	9.5	06	3/8-19	22	17	23	23	
2321-06-08	3/8	9.5	06	1/2-14	27	19	26	28	
2321-08-08	1/2	12.7	08	1/2-14	27	22	27	26	
2321-10-10	5/8	15.9	10	5/8-14	30	24	28	29	
2321-12-12	3/4	19	12	3/4-14	32	27	32	32	
2321-16-16	1	25.4	16	1-11	38	32	36	38	
2300-20-20	1.1/4	31.8	20	1.1/4-11	50	-	46	47	

0041

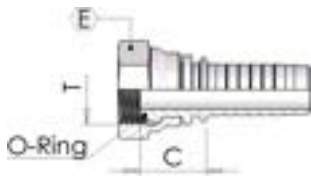

0048

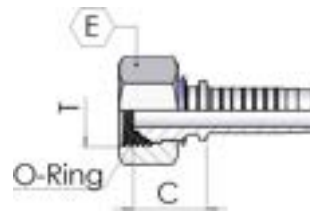

BSP O'Ring Female 60° Cone

(DKOR)

Product number	hose I.D.		Dimension			
	in	mm	dash size	T	E	Cut-off C
0048-04-04	1/4	6.4	04	1/4-19	19	22
0048-04-06	1/4	6.4	04	3/8-19	22	20
0048-06-06	3/8	9.5	06	3/8-19	22	20
0048-06-08	3/8	9.5	06	1/2-14	27	23
0048-08-08	1/2	12.7	08	1/2-14	27	23
0041-10-10	5/8	15.9	10	5/8-14	30	21
0041-12-12	3/4	19	12	5/8-14	32	26
0041-16-16	1	25.4	16	1-11	38	28

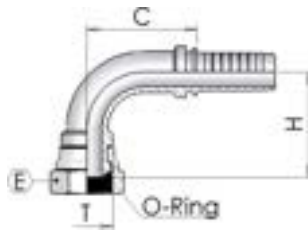
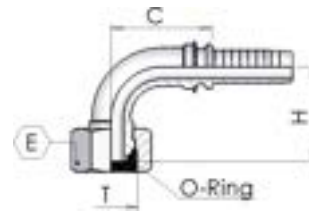
0141**0148**

BSP O'Ring 90° Swept elbow 60° cone

(DKOR 90°)

Product number	hose I.D.		Dimension				
	in	mm	dash size	T	E	drop H	Cut-off C
0148-04-04	1/4	6.4	04	1/4-19	19	22	27
0148-04-06	1/4	6.4	04	3/8-19	22	23	27
0148-06-06	3/8	9.5	06	3/8-19	22	23	27
0148-06-08	3/8	9.5	06	1/2-14	27	30	33
0148-08-08	1/2	12.7	08	1/2-14	27	35	42
0141-10-10	5/8	15.9	10	5/8-14	30	54	37
0141-12-12	3/4	19	12	3/4-14	32	58	56
0141-16-16	1	25.4	16	1-11	38	37	70

0241

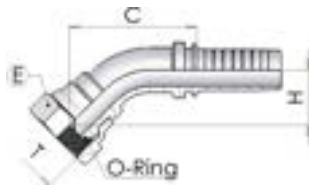

0248

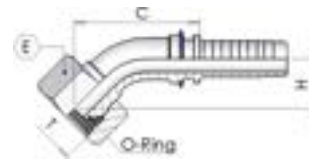

BSP O'Ring 45° Swept Elbow 60° Cone (DKOR 45°)

Product number	hose I.D.		Dimension				
	in	mm	dash size	T	E	drop H	Cut-off C
0248-04-04	1/4	6.4	04	1/4-19	19	15	41
0248-06-06	3/8	9.5	06	3/8-19	22	15	47
0248-08-08	1/2	12.7	08	1/2-14	27	19	61
0241-12-12	3/4	19	12	3/4-14	32	28	88
0241-16-16	1	25.4	16	1-11	38	32	114

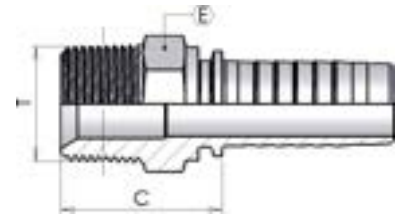
0360**BSP Taper Male 60° cone****(AGR-K)**

Product number	hose I.D.		Dimension			
	in	mm	dash size	T	E	Cut-off C
0360-03-02	3/16	4.8	03	1/8-28	12	21
0360-03-04	3/16	4.8	03	1/4-19	15	27
0360-04-02	1/4	6.4	04	1/8-28	12	22
0360-04-04	1/4	6.4	04	1/4-19	15	28
0360-04-06	1/4	6.4	04	3/8-19	19	28
0360-05-04	5/16	7.9	05	1/4-19	15	28
0360-05-06	5/16	7.9	05	3/8-19	19	28
0360-06-04	3/8	9.5	06	1/4-19	17	28
0360-06-06	3/8	9.5	06	3/8-19	19	28
0360-06-08	3/8	9.5	06	1/2-14	22	33
0360-08-06	1/2	12.7	08	3/8-19	19	29
0360-08-08	1/2	12.7	08	1/2-14	22	34
0360-08-12	1/2	12.7	08	3/4-14	27	36
0360-12-12	3/4	19	12	3/4-14	27	37
0360-12-16	3/4	19	12	1-11	36	43
0360-16-16	1	25.4	16	1-11	36	44
0360-20-20	1.1/4	31.8	20	1.1/4-11	46	47
0360-24-24	1.1/2	38.1	24	1.1/2-11	50	49
0360-32-32	2	50.8	32	2-11	65	55

0370

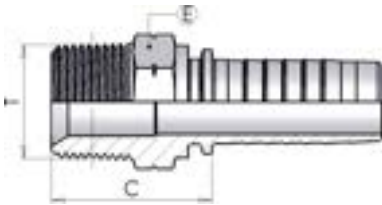

NPTF Male 60° cone

(AGN)

Product number	hose I.D.		Dimension			
	in	mm	dash size	T	E	Cut-off C
0370-03-02	3/16	4.8	03	1/8-27	12	22
0370-03-04	3/16	4.8	03	1/4-18	15	27
0370-04-02	1/4	6.4	04	1/8-27	12	22
0370-04-04	1/4	6.4	04	1/4-18	15	28
0370-04-06	1/4	6.4	04	3/8-18	19	28
0370-05-04	5/16	7.9	05	1/4-18	15	28
0370-05-06	5/16	7.9	05	3/8-18	19	28
0370-06-04	3/8	9.5	06	1/4-18	17	28
0370-06-06	3/8	9.5	06	3/8-18	19	28
0370-06-08	3/8	9.5	06	1/2-14	22	34
0370-08-06	1/2	12.7	08	3/8-18	19	29
0370-08-08	1/2	12.7	08	1/2-14	22	35
0370-08-12	1/2	12.7	08	3/4-14	27	36
0370-10-08	5/8	15.8	10	1/2-14	24	35
0370-10-12	5/8	15.8	10	3/4-14	27	36
0370-12-08	3/4	19	12	1/2-14	24	36
0370-12-12	3/4	19	12	3/4-14	27	37
0370-12-16	3/4	19	12	1-11.1/2	36	43
0370-16-16	1	25.4	16	1-11.1/2	36	44
0370-20-20	1.1/4	31.8	20	1.1/4-11.1/2	46	47
0370-24-24	1.1/2	38.1	24	1.1/2-11.1/2	50	49
0370-32-32	2	50.8	32	2-11.1/2	65	55
0370-40-40	2.1/2	63.5	40	2.1/2-8	80	55
0370-48-48	3	76.2	48	3-8	90	58

037G

NPTF Male Parallel 60° Cone - Rotating (AGN-RO)

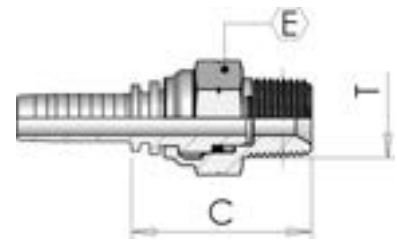

Product number	hose I.D.		Dimension			
	in	mm	dash size	T	E	Cut-off C
037G-04-04	1/4	6.4	04	1/4-18	19	39
037G-06-06	3/8	9.5	06	3/8-18	22	43
037G-08-08	1/2	12.7	08	1/2-14	27	49
037G-12-12	3/4	19	12	3/4-14	32	52

N051

NPSM Female 60° Cone Rolled Nut (DKN)

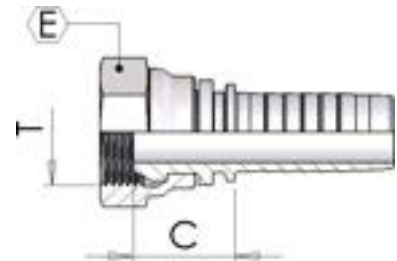

Product number	hose I.D.		Dimension			
	in	mm	dash size	T	E	Cut-off C
N051-03-04	3/16	4.8	03	1/4-18	19	17
N051-04-04	1/4	6.4	04	1/4-18	19	17
N051-06-06	3/8	9.5	06	3/8-18	22	19
N051-08-08	1/2	12.7	08	1/2-14	27	23
N051-12-12	3/4	19	12	3/4-14	32	25
N051-16-16	1	25.4	16	1-11	38	27

0850

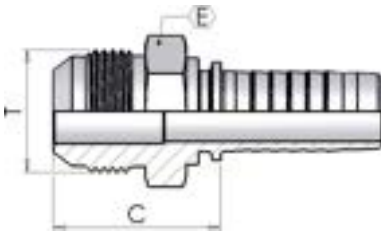

JIC Male 74° cone

(AGJ)

Product number	hose I.D.		Dimension				Note
	in	mm	dash size	T	E	Cut-off C	
0850-03-04	3/16	4.8	03	7/16-20	12	26	
0850-04-04	1/4	6.4	04	7/16-20	12	27	
0850-04-05	1/4	6.4	04	1/2-20	14	27	
0850-04-06	1/4	6.4	04	9/16-18	15	27	
0850-05-05	5/16	7.9	05	1/2-20	14	27	
0850-05-06	5/16	7.9	05	9/16-18	15	27	
0850-05-08	5/16	7.9	05	3/4-16	19	30	
0850-06-06	3/8	9.5	06	9/16-18	15	27	
0850-06-07	3/8	9.5	06	5/8-18	17	30	* SAE 45°
0850-06-08	3/8	9.5	06	3/4-16	19	30	
0850-06-10	3/8	9.5	06	7/8-14	24	34	
0850-08-08	1/2	12.7	08	3/4-16	19	31	
0850-08-10	1/2	12.7	08	7/8-14	24	35	
0850-08-12	1/2	12.7	08	1.1/16-12	27	37	
0850-10-10	5/8	15.9	10	7/8-14	24	35	
0850-10-12	5/8	15.9	10	1.1/16-12	27	37	
0850-12-10	3/4	19	12	7/8-14	24	36	
0850-12-12	3/4	19	12	1.1/16-12	27	38	
0850-12-14	3/4	19	12	1.3/16-12	32	41	
0850-12-16	3/4	19	12	1.5/16-12	34	42	
0850-16-12	1	25.4	16	1.1/16-12	27	39	
0850-16-16	1	25.4	16	1.5/16-12	34	43	
0850-16-20	1	25.4	16	1.5/8-12	42	46	
0850-20-20	1.1/4	31.8	20	1.5/8-12	42	47	
0850-20-24	1.1/4	31.8	20	1.7/8-12	50	52	
0850-24-24	1.1/2	38.1	24	1.7/8-12	50	52	
0850-32-32	2	50.8	32	2.1/2-12	65	62	

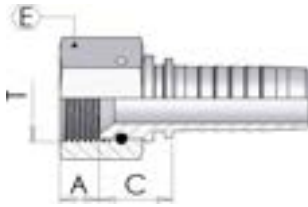
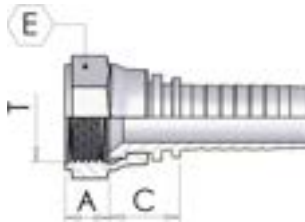
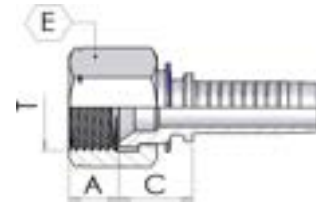
0900**0901****0902****JIC Female 74°****(DKJ)**

Product number	hose I.D.		Dimension				
	in	mm	dash size	T	E	Cut-off C	A
0901-03-04	3/16	4.8	03	7/16-20	15	14	8.5
0901-03-05	3/16	4.8	03	1/2-20	17	14	9.5
0901-04-04	1/4	6.4	04	7/16-20	15	14	8.5
0902-04-05	1/4	6.4	04	1/2-20	17	17	9.5
0902-04-06	1/4	6.4	04	9/16-18	19	17	9
0901-04-07	1/4	6.4	04	5/8-18	22	17	11
0901-05-05	5/16	7.9	05	1/2-20	17	15	9.5
0901-05-07	5/16	7.9	05	5/8-18	22	17	11
0901-06-04	3/8	9.5	06	7/16-20	15	15	9
0901-06-05	3/8	9.5	06	1/2-20	17	15	9.5
0901-06-06	3/8	9.5	06	9/16-18	19	16	9
0901-06-07	3/8	9.5	06	5/8-18	22	16	11
0902-06-08	3/8	9.5	06	3/4-16	22	18	10.5
0901-08-08	1/2	12.7	08	3/4-16	24	18	10.5
0902-08-10	1/2	12.7	08	7/8-14	27	20	13
0901-10-10	5/8	15.9	10	7/8-14	27	20	13
0902-10-12	5/8	15.9	10	1.1/16-12	32	20	13.5
0901-12-10	3/4	19	12	7/8-14	27	20	13
0902-12-12	3/4	19	12	1.1/16-12	32	22	13.5
0901-12-14	3/4	19	12	1.3/16-12	36	23	14
0901-12-16	3/4	19	12	1.5/16-12	38	23	15.5
0901-16-12	1	25.4	12	1.1/16-12	32	23	13.5
0901-16-16	1	25.4	16	1.5/16-12	38	24	15.5
0900-16-20	1	25.4	16	1.5/8-12	50	27	16.5
0900-20-20	1.1/4	31.8	20	1.5/8-12	50	28	16.5
0900-20-24	1.1/4	31.8	20	1.7/8-12	55	31	19
0900-24-24	1.1/2	38.1	24	1.7/8-12	55	31	19
0900-32-32	2	50.8	32	2.1/2-12	70	31	20

0901D

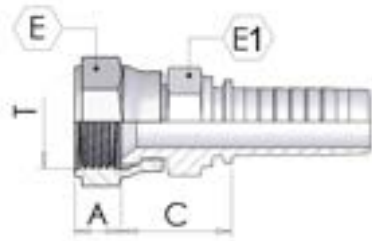

JIC Female 74° Cone- Double Hexagon

(DKJ)

Product number	hose I.D.		Dimension						
	in	mm	dash size	T	E	E1	Cut-off C	A	
0901D04-04	1/4	6.4	04	7/16-20	15	12	20	8.5	
0901D04-05	1/4	6.4	04	1/2-20	17	14	20	9.5	
0901D04-06	1/4	6.4	04	9/16-18	19	14	22	9	
0901D06-06	3/8	9.5	06	9/16-18	19	17	24	9	
0901D06-08	3/8	9.5	06	3/4-16	24	19	26	10.5	
0901D08-08	1/2	12.7	08	3/4-16	24	22	26	10.5	
0901D08-10	1/2	12.7	08	7/8-14	27	22	27	13	
0901D10-10	5/8	15.9	10	7/8-14	27	22	26	13	
0901D10-12	5/8	15.9	10	1.1/16-12	32	27	27	13.5	
0901D12-12	3/4	19	12	1.1/16-12	32	27	32	13.5	
0901D16-16	1	25.4	16	1.5/16-12	38	36	33	15.5	

0950

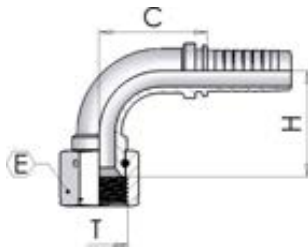

0951



0952

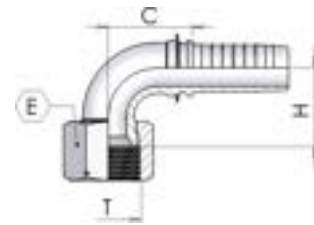

JIC 90° Swept Elbow 74° cone

Product number	hose I.D.		Dimension				
	in	mm	dash size	T	E	drop H	Cut-off C
0951-03-04	3/16	4.8	03	7/16-20	15	22	22
0951-03-05	3/16	4.8	03	1/2-20	17	22	22
0951-04-04	1/4	6.4	04	7/16-20	15	22	22
0952-04-05	1/4	6.4	04	1/2-20	17	21	27
0952-04-06	1/4	6.4	04	9/16-18	19	21	26
0951-05-05	5/16	7.9	05	1/2-20	17	30	29
0951-05-06	5/16	7.9	05	9/16-18	19	31	29
0951-06-05	3/8	9.5	06	1/2-20	17	33	30
0951-06-06	3/8	9.5	06	9/16-18	19	32	31
0951-06-07	3/8	9.5	06	5/8-18	22	32	33
0952-06-08	3/8	9.5	06	3/4-16	22	34	41
0951-06-10	3/8	9.5	06	7/8-14	27	36	33
0951-08-08	1/2	12.7	08	3/4-16	24	41	41
0952-08-10	1/2	12.7	08	7/8-14	27	34	41
0951-08-12	1/2	12.7	08	1.1/16-12	32	43	42
0951-10-10	5/8	15.9	10	7/8-14	27	44	43
0951-12-10	3/4	19	12	7/8-14	27	53	56
0952-10-12	5/8	15.9	10	1.1/16-12	32	37	47
0952-12-12	3/4	19	12	1.1/16-12	32	45	58
0951-12-14	3/4	19	12	1.3/16-12	36	53	56
0951-12-16	3/4	19	12	1.5/16-12	38	55	60
0951-16-12	1	25.4	16	1.1/16-12	38	55	60
0951-16-16	1	25.4	16	1.5/16-12	32	63	63
0950-20-20	1.1/4	31.8	20	1.5/8-12	50	85	82
0950-24-24	1.1/2	38.1	24	1.7/8-12	55	97	104
0950-32-32	2	50.8	32	2.1/2-12	70	134	124

1000

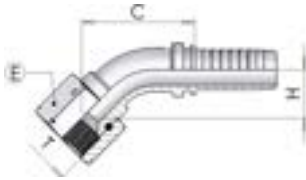

1001

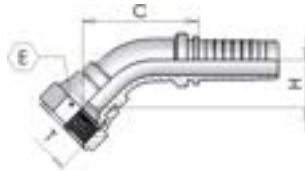

1002

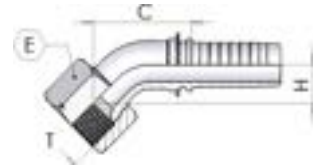

JIC 45° Swept Elbow 74°

(DKJ-45°)

Product number	hose I.D.		Dimension				
	in	mm	dash size	T	E	drop H	Cut-off C
1001-03-04	3/16	4.8	03	7/16-20	15	15	33
1001-04-04	1/4	6.4	04	7/16-20	15	13	38
1002-04-05	1/4	6.4	04	1/2-20	17	11	38
1002-04-06	1/4	6.4	04	9/16-18	19	11	38
1001-05-05	5/16	7.9	05	1/2-20	17	17	46
1001-05-06	5/16	7.9	05	9/16-18	19	18	47
1001-06-05	3/8	9.5	06	1/2-20	17	18	49
1001-06-06	3/8	9.5	06	9/16-18	19	17	51
1002-06-08	3/8	9.5	06	3/4-16	22	13	48
1001-06-10	3/8	9.5	06	7/8-14	27	21	54
1001-08-08	1/2	12.7	08	3/4-16	24	22	62
1002-08-10	1/2	12.7	08	7/8-14	27	16	58
1001-08-12	1/2	12.7	08	1.1/16-12	32	25	68
1001-10-10	5/8	15.9	10	7/8-14	27	24	68
1002-10-12	5/8	15.9	10	1.1/16-12	32	18	66
1002-12-12	3/4	19	12	1.1/16-12	32	21	81
1001-12-14	3/4	19	12	1.3/16-12	36	29	84
1001-12-16	3/4	19	12	1.5/16-12	38	28	88
1001-16-16	1	25.4	16	1.5/16-12	38	29	83
1000-20-20	1.1/4	31.8	20	1.5/8-12	50	42	108
1000-24-24	1.1/2	38.1	24	1.7/8-12	55	49	119
1000-32-32	2	50.8	32	2.1/2-12	70	65	142

095S

JIC 90° Swept Elbow 74° cone - ISO SHORT

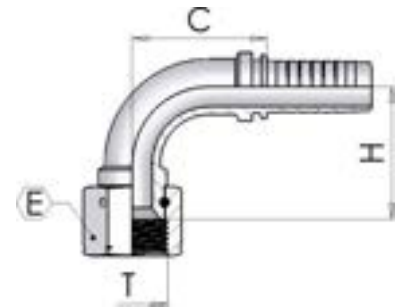

Product number	hose I.D.		Dimension				
	in	mm	dash size	T	E	drop H	Cut-off C
095S-04-04	1/4	6.4	04	7/16-20	15	22	25
095S-06-06	3/8	9.5	06	9/16-18	19	23	31
095S-08-08	1/2	12.7	08	3/4-16	24	29	41
095S-10-10	5/8	15.9	10	7/8-14	27	32	43
095S-12-12	3/4	19	12	1.1/16-12	32	48	56
095S-16-16	1	25.4	16	1.5/16-12	41	57	70

2971

JIC 90° Compact Elbow 74° cone - Crimped Nut (DKJ-90°K)

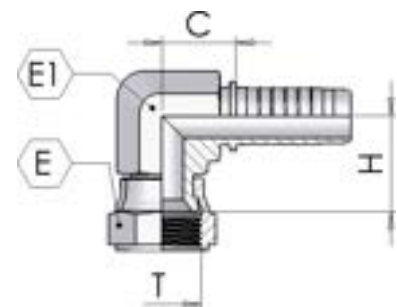

Product number	hose I.D.		Dimension					
	in	mm	dash size	T	E	E1	drop H	Cut-off C
2971-04-04	1/4	6.4	04	7/16-20	15	15	17	19
2971-04-05	1/4	6.4	04	1/2-20	17	15	18	19
2971-04-06	1/4	6.4	04	9/16-18	19	15	21	19
2971-05-06	5/16	7.9	05	9/16-18	19	17	21	23
2971-06-06	3/8	9.5	06	9/16-18	19	17	20	24
2971-06-08	3/8	9.5	06	3/4-16	24	19	22	25
2971-08-08	1/2	12.7	08	3/4-16	24	22	22.5	26.5
2971-08-10	1/2	12.7	08	7/8-14	27	22	23.5	26.5
2971-12-12	3/4	19.1	12	1.1/16-12	32	27	28.5	31.5
2971-16-16	1	25.4	16	1.5/16-12	38	32	32	33.5

0385

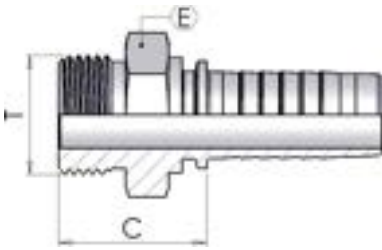

SAE Male O'R Flat Seat

(SAE-OR)

Product number	hose I.D.		Dimension			
	in	mm	dash size	T	E	Cut-off C
0385-04-04	1/4	6.4	04	7/16-20	14	24
0385-04-06	1/4	6.4	04	9/16-18	17	24
0385-05-06	5/16	7.9	05	9/16-18	17	24
0385-06-06	3/8	9.5	06	9/16-18	17	25
0385-06-08	3/8	9.5	06	3/4-16	22	28
0385-08-08	1/2	12.7	08	3/4-16	22	28
0385-08-10	1/2	12.7	08	7/8-14	27	30
0385-08-12	1/2	12.7	08	1.1/16-12	32	32
0385-10-10	5/8	15.9	10	7/8-14	27	30
0385-10-12	5/8	15.9	10	1.1/16-12	32	32
0385-12-12	3/4	19	12	1.1/16-12	32	33

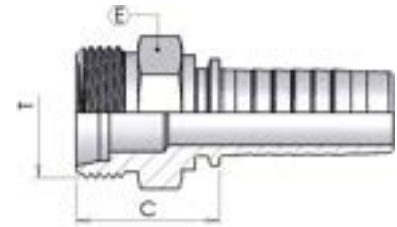
Metric Male 24° Seat Light**(CEL)**

Product number	hose I.D.		Dimension				
	in	mm	dash size	T	erm.	E	Cut-off C
0500-03-12	3/16	4.8	03	M12-1.5	6	14	22
0500-03-14	3/16	4.8	03	M14-1.5	8	14	22
0500-04-12	1/4	6.4	04	M12-1.5	6	14	23
0500-04-14	1/4	6.4	04	M14-1.5	8	14	22
0500-04-16	1/4	6.4	04	M16-1.5	10	17	23
0500-04-18	1/4	6.4	04	M18-1.5	12	19	24
0500-05-14	5/16	7.9	05	M14-1.5	8	14	22
0500-05-16	5/16	7.9	05	M16-1.5	10	17	23
0500-05-18	5/16	7.9	05	M18-1.5	12	19	24
0500-05-22	5/16	7.9	05	M22-1.5	15	22	25
0500-06-16	3/8	9.5	06	M16-1.5	10	17	23
0500-06-18	3/8	9.5	06	M18-1.5	12	19	24
0500-06-22	3/8	9.5	06	M22-1.5	15	22	25
0500-08-18	1/2	12.7	08	M18-1.5	12	19	25
0500-08-22	1/2	12.7	08	M22-1.5	15	22	26
0500-08-26	1/2	12.7	08	M26-1.5	18	27	27
0500-10-22	5/8	15.9	10	M22-1.5	15	22	26
0500-10-26	5/8	15.9	10	M26-1.5	18	27	27
0500-10-30	5/8	15.9	10	M30-2	22	30	32
0500-12-26	3/4	19	12	M26-1.5	18	27	28
0500-12-30	3/4	19	12	M30-2	22	30	33
0500-16-36	1	25.4	16	M36-2	28	36	32
0500-20-45	1.1/4	31.8	20	M45-2	35	46	36
0500-24-52	1.1/2	38.1	24	M52-2	42	55	38

0085

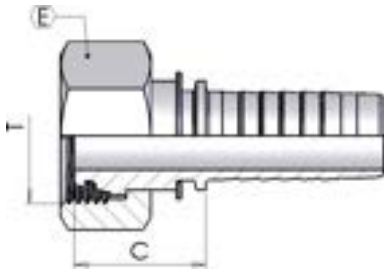

Metric Female 24° Seat Light

(DKOL)

Product number	hose I.D.		Dimension				
	in	mm	dash size	T	erm.	E	Cut-off C
0085-03-12	3/16	4.8	03	M12-1.5	6	14	23
0085-03-14	3/16	4.8	03	M14-1.5	8	17	24
0085-04-12*	1/4	6.4	04	M12-1.5	6	14	25
0085-04-14	1/4	6.4	04	M14-1.5	8	17	24
0085-04-16	1/4	6.4	04	M16-1.5	10	19	24
0085-04-18	1/4	6.4	04	M18-1.5	12	22	25
0085-05-14*	5/16	7.9	05	M14-1.5	8	19	26
0085-05-16	5/16	7.9	05	M16-1.5	10	19	24
0085-05-18	5/16	7.9	05	M18-1.5	12	22	25
0085-06-16*	3/8	9.5	06	M16-1.5	10	19	25
0085-06-18	3/8	9.5	06	M18-1.5	12	22	25
0085-06-22	3/8	9.5	06	M22-1.5	15	27	29
0085-08-18*	1/2	12.7	08	M18-1.5	12	24	28
0088-08-18	1/2	12.7	08	M18-1.5	12	22	28
0085-08-22	1/2	12.7	08	M22-1.5	15	27	29
0085-08-26	1/2	12.7	08	M26-1.5	18	32	29
0085-10-22*	5/8	15.9	10	M22-1.5	15	27	31
0085-10-26	5/8	15.9	10	M26-1.5	18	32	29
0085-10-30	5/8	15.9	10	M30-2	22	36	29
0085-12-26*	3/4	19	12	M26-1.5	18	32	35
0085-12-30	3/4	19	12	M30-2	22	36	29
0085-12-36	3/4	19	12	M36-2	28	41	28
0085-16-36	1	25.4	16	M36-2	28	41	30
0085-20-45	1.1/4	31.8	20	M45-2	35	50	40
0085-20-52	1.1/4	31.8	20	M52-2	42	60	43
0085-24-52	1.1/2	38.1	24	M52-2	42	60	41

*Rolled Nut

0185

90° Metric Swept Elbow 24° Seat Light

(DKOL-90°)

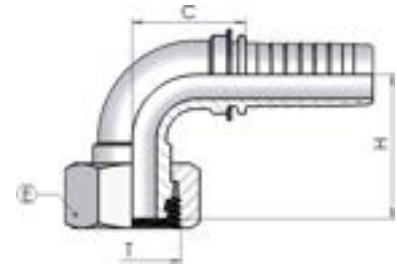

Product number	hose I.D.		Dimension					
	in	mm	dash size	T	erm.	E	drop H	Cut-off C
0185-03-12	3/16	4.8	03	M12-1.5	6	14	23	22
0185-03-14	3/16	4.8	03	M14-1.5	8	17	24	23
0185-04-12*	1/4	6.4	04	M12-1.5	6	14	34	26
0185-04-14	1/4	6.4	04	M14-1.5	8	17	26	26
0185-04-16	1/4	6.4	04	M16-1.5	10	19	27	24
0185-04-18	1/4	6.4	04	M18-1.5	12	22	30	27
0185-05-14*	5/16	7.9	05	M14-1.5	8	19	38	30
0185-05-16	5/16	7.9	05	M16-1.5	10	19	31	31
0185-05-18	5/16	7.9	05	M18-1.5	12	22	32	31
0185-06-16*	3/8	9.5	06	M16-1.5	10	19	39	32
0185-06-18	3/8	9.5	06	M18-1.5	12	22	35	32
0185-06-22	3/8	9.5	06	M22-1.5	15	27	35	32
0185-08-18*	1/2	12.7	08	M18-1.5	12	24	48	40
0185-08-22	1/2	12.7	08	M22-1.5	15	27	38	41
0185-08-26	1/2	12.7	08	M26-1.5	18	32	39	41
0185-10-22*	5/8	15.9	10	M22-1.5	15	27	55	42
0185-10-26	5/8	15.9	10	M26-1.5	18	32	44	44
0185-12-30	3/4	19	12	M30-2	22	36	52	58
0185-16-36	1	25.4	16	M36-2	28	41	62	72
0185-20-45	1.1/4	31.8	20	M45-2	35	50	81	84
0185-24-52	1.1/2	38.1	24	M52-2	42	60	93	102

*Rolled Nut

0285

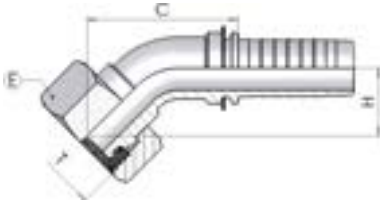

45° Metric Swept Elbow 24° Seat Light

(DKOL-45°)

Product number	hose I.D.		Dimension					
	in	mm	dash size	T	erm.	E	H	Cut-off C
0285-03-12	3/16	4.8	03	M12-1.5	6	14	14	36
0285-04-12*	1/4	6.4	04	M12-1.5	6	14	21	46
0285-04-14	1/4	6.4	04	M14-1.5	8	17	14	42
0285-04-16	1/4	6.4	04	M16-1.5	10	19	15	42
0285-04-18	1/4	6.4	04	M18-1.5	12	22	16	43
0285-05-16	5/16	7.9	05	M16-1.5	10	19	17	48
0285-05-18	5/16	7.9	05	M18-1.5	12	22	18	48
0285-06-16*	3/8	9.5	06	M16-1.5	10	19	22	55
0285-06-18	3/8	9.5	06	M18-1.5	12	22	19	52
0285-06-22	3/8	9.5	06	M22-1.5	15	27	19	51
0285-08-22	1/2	12.7	08	M22-1.5	15	27	21	63
0285-08-26	1/2	12.7	08	M26-1.5	18	32	22	63
0285-10-22*	5/8	15.9	10	M22-1.5	15	27	32	75
0285-10-26	5/8	15.9	10	M26-1.5	18	32	23	68
0285-12-30	3/4	19	12	M30-2	22	36	25	86
0285-16-36	1	25.4	16	M36-2	28	41	29	81
0285-20-45	1.1/4	31.8	20	M45-2	35	50	32	106
0285-24-52	1.1/2	38.1	24	M52-2	42	60	42	118

*Rolled Nut

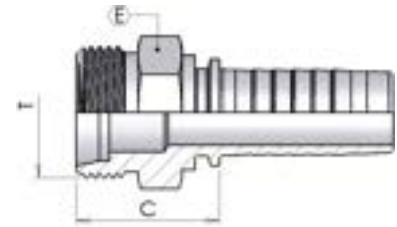
0450**Metric Male 24° Seat Heavy****(CES)**

Product number	hose I.D.		Dimension				
	in	mm	dash size	T	erm.	E	Cut-off C
0450-03-16	3/16	4.8	03	M16-1.5	8	17	26
0450-04-14	1/4	6.4	04	M14-1.5	6	14	25
0450-04-16	1/4	6.4	04	M16-1.5	8	17	27
0450-04-18	1/4	6.4	04	M18-1.5	10	19	27
0450-04-20	1/4	6.4	04	M20-1.5	12	22	27
0450-05-18	5/16	7.9	05	M18-1.5	10	19	27
0450-05-20	5/16	7.9	05	M20-1.5	12	22	29
0450-06-18	3/8	9.5	06	M18-1.5	10	19	27
0450-06-20	3/8	9.5	06	M20-1.5	12	22	29
0450-06-22	3/8	9.5	06	M22-1.5	14	22	31
0450-06-24	3/8	9.5	06	M24-1.5	16	24	31
0450-08-20	1/2	12.7	08	M20-1.5	12	22	29
0450-08-22	1/2	12.7	08	M22-1.5	14	22	31
0450-08-24	1/2	12.7	08	M24-1.5	16	24	32
0450-08-30	1/2	12.7	08	M30-2	20	30	33
0450-10-30	5/8	15.9	10	M30-2	20	30	34
0450-12-30	3/4	19	12	M30-2	20	30	35
0450-12-36	3/4	19	12	M36-2	25	36	38
0450-16-36	1	25.4	16	M36-2	25	36	39
0450-16-42	1	25.4	16	M42-2	30	46	42
0450-20-42	1.1/4	31.8	20	M42-2	30	46	43
0450-20-52	1.1/4	31.8	20	M52-2	38	55	45
0450-24-52	1.1/2	38.1	24	M52-2	38	55	45

0084

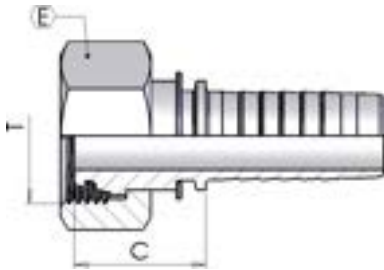

Metric Female 24° Seat Heavy

(DKOS)

Product number	hose I.D.		Dimension					Note
	in	mm	dash size	T	erm.	E	Cut-off C	
0084-03-14	3/16	4.8	03	M14-1.5	6	17	22	
0084-03-16	3/16	4.8	03	M16-1.5	8	19	25	
0084-04-14	1/4	6.4	04	M14-1.5	6	17	23	
0084-04-16	1/4	6.4	04	M16-1.5	8	19	25	
0084-04-18	1/4	6.4	04	M18-1.5	10	22	24	
0084-04-20	1/4	6.4	04	M20-1.5	12	24	22	
0084-05-16	5/16	7.9	05	M16-1.5	8	19	26	
0084-05-18	5/16	7.9	05	M18-1.5	10	22	25	
0084-05-20	5/16	7.9	05	M20-1.5	12	24	25	
0084-06-18	3/8	9.5	06	M18-1.5	10	22	25	
0084-06-20	3/8	9.5	06	M20-1.5	12	24	25	
0084-06-22	3/8	9.5	06	M22-1.5	14	27	29	
0084-06-24	3/8	9.5	06	M24-1.5	16	30	29	
0084-08-20*	1/2	12.7	08	M20-1.5	12	27	28	(*)
0084-08-22	1/2	12.7	08	M22-1.5	14	27	17	
0084-08-24	1/2	12.7	08	M24-1.5	16	30	30	
0084-08-30	1/2	12.7	08	M30-2	20	36	33	
0084-10-24*	5/8	15.9	10	M24-1.5	16	30	31	(*)
0084-10-30	5/8	15.9	10	M30-2	20	36	33	
0084-12-30	3/4	19	12	M30-2	20	36	34	
0084-12-36	3/4	19	12	M36-2	25	46	40	
0084-16-36	1	25	16	M36-2	25	46	41	
0084-16-42	1	25	16	M42-2	30	50	43	
0084-20-52	1.1/4	31.8	20	M52-2	38	60	44	
0084-24-52	1.1/2	38.1	24	M52-2	38	60	44	

*Rolled Nut

0184

90° Metric Swept Elbow 24° Seat Heavy

(DKOS-90°)

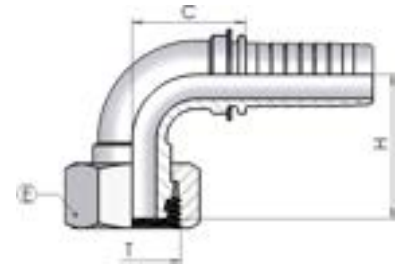

Product number	hose I.D.		Dimension					
	in	mm	dash size	T	erm.	E	drop H	Cut-off C
0184-03-16	3/16	4.8	03	M16-1.5	8	19	25	22
0184-04-14	1/4	6.4	04	M14-1.5	6	17	26	27
0184-04-16	1/4	6.4	04	M16-1.5	8	19	26	26
0184-04-18	1/4	6.4	04	M18-1.5	10	22	31	27
0184-04-20	1/4	6.4	04	M20-1.5	12	24	30	27
0184-05-18	5/16	7.9	05	M18-1.5	10	22	33	33
0184-05-20	5/16	7.9	05	M20-1.5	12	24	34	30
0184-06-18	3/8	9.5	06	M18-1.5	10	22	35	34
0184-06-20	3/8	9.5	06	M20-1.5	12	24	34	34
0184-06-22	3/8	9.5	06	M22-1.5	14	27	33	33
0184-06-24	3/8	9.5	06	M24-1.5	16	30	35	33
0184-08-20*	1/2	12.7	08	M20-1.5	12	27	48	40
0184-08-22	1/2	12.7	08	M22-1.5	14	27	41	41
0184-08-24	1/2	12.7	08	M24-1.5	16	30	41	40
0184-10-24*	5/8	15.9	10	M24-1.5	16	30	60	42
0184-10-30	5/8	15.9	10	M30-2	20	36	50	46
0184-12-30	3/4	19	12	M30-2	20	36	56	58
0184-12-36	3/4	19	12	M36-2	25	46	57	59
0184-16-36	1	25.4	16	M36-2	25	46	67	77
0184-16-42	1	25.4	16	M42-2	30	50	67	72
0184-20-52	1.1/4	31.8	20	M52-2	38	60	82	84
0184-24-52	1.1/2	38.1	24	M52-2	38	60	105	105

*Rolled Nut

0284

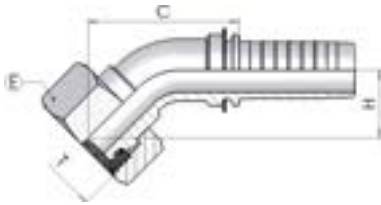

45° Metric Swept Elbow 24° Seat Heavy

(DKOS-45°)

Product number	hose I.D.		Dimension				
	in	mm	dash size	T	erm.	E	Cut-off C
0284-03-16	3/16	4.8	03	M16-1.5	8	19	36
0284-04-14	1/4	6.4	04	M14-1.5	6	17	37
0284-04-16	1/4	6.4	04	M16-1.5	8	19	42
0284-04-18	1/4	6.4	04	M18-1.5	10	22	45
0284-05-20	5/16	7.9	05	M20-1.5	12	24	49
0284-06-18	3/8	9.5	06	M18-1.5	10	22	51
0284-06-20	3/8	9.5	06	M20-1.5	12	24	53
0284-06-22	3/8	9.5	06	M22-1.5	14	27	54
0284-08-24	1/2	12.7	08	M24-1.5	16	30	63
0284-10-30	5/8	15.9	10	M30-2	20	36	74
0284-12-30	3/4	19	12	M30-2	20	36	87
0284-12-36	3/4	19	12	M36-2	25	46	75
0284-16-36	1	25.4	16	M36-2	25	46	85
0284-16-42	1	25.4	16	M42-2	30	50	85
0284-20-52	1.1/4	31.8	20	M52-2	38	60	105
0284-24-52	1.1/2	38.1	24	M52-2	38	60	129

0550

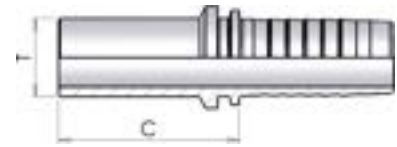
Metric Standpipe**(BEL-BES)**

Product number	hose I.D.		Dimension			
	in	mm	dash size	Pipe T	Type	Cut-off C
0550-03-06	3/16	4.8	03	6	L/S	30
0550-03-08	3/16	4.8	03	8	L/S	29
0550-04-06	1/4	6.4	04	6	L/S	32
0550-04-08	1/4	6.4	04	8	L/S	30
0550-04-10	1/4	6.4	04	10	L/S	33
0550-04-12	1/4	6.4	04	12	L/S	30
0550-05-08	5/16	7.9	05	08	L/S	31
0550-05-10	5/16	7.9	05	10	L/S	31
0550-05-12	5/16	7.9	05	12	L/S	33
0550-06-08	3/8	9.5	06	08	L/S	33
0550-06-10	3/8	9.5	06	10	L/S	33
0550-06-12	3/8	9.5	06	12	L/S	32
0550-06-14	3/8	9.5	06	14	S	37
0550-06-15	3/8	9.5	06	15	L	32
0550-08-12	1/2	12.7	08	12	L/S	36
0550-08-15	1/2	12.7	08	15	L	34
0550-08-16	1/2	12.7	08	16	S	39
0550-08-18	1/2	12.7	08	18	L	35
0550-10-18	5/8	15.9	10	18	L	35
0550-10-20	5/8	15.9	10	20	S	45
0550-10-22	5/8	15.9	10	22	L	33
0550-12-18	3/4	19	12	18	L	37
0550-12-20	3/4	19	12	20	S	46
0550-12-22	3/4	19	12	22	L	38
0550-12-25	3/4	19	12	25	S	49
0550-12-28	3/4	19	12	28	L	40
0550-16-25	1	25.4	16	25	S	51
0550-16-28	1	25.4	16	28	L	41
0550-16-30	1	25.4	16	30	S	54
0550-20-30	1.1/4	31.8	20	30	S	58
0550-20-35	1.1/4	31.8	20	35	L	48
0550-24-38	1.1/2	38.1	24	38	S	63
0550-24-42	1.1/2	38.1	24	42	L	50

0650

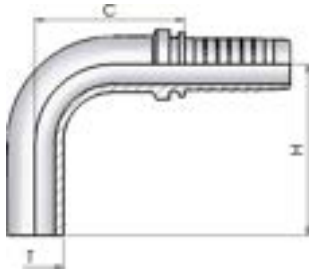

0650S

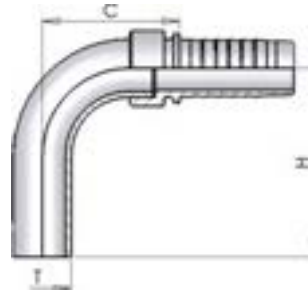

90° Metric Standpipe

(BEL-BES 90°)

Product number	hose I.D.		Dimension				
	in	mm	dash size	Pipe T	Type	drop H	Cut-off C
0650-03-06	3/16	4.8	03	6	L/S	32	20
0650S03-08	3/16	4.8	03	8	L/S	41	25
0650-04-06	1/4	6.4	04	6	L/S	32	23
0650-04-08	1/4	6.4	04	8	L/S	34	25
0650-04-10	1/4	6.4	04	10	L/S	43	25
0650S04-12	1/4	6.4	04	12	L/S	44	35
0650-05-10	5/16	7.9	05	10	L/S	40	29
0650-05-12	5/16	7.9	05	12	L/S	45	29
0650-06-10	3/8	9.5	06	10	L/S	40	27
0650-06-12	3/8	9.5	06	12	L/S	44	30
0650S06-15	3/8	9.5	06	15	L	52	39
0650S08-12	1/2	12.7	08	12	L/S	44	33
0650S08-15	1/2	12.7	08	15	L	52	39
0650S08-18	1/2	12.7	08	18	L	56	42
0650S10-18	5/8	15.9	10	18	L	56	51
0650S12-22	3/4	19	12	22	L	71	51
0650S12-25	3/4	19	12	25	S	75	57
0650S16-25	1	25.4	16	25	S	75	57
0650S16-28	1	25.4	16	28	L	89	60
0650S24-42	1.1/2	38.1	24	42	L	125	106

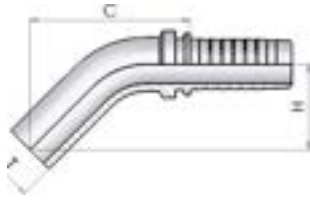
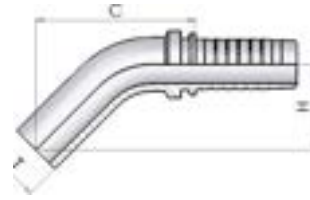
0750**0750S****45° Metric Standpipe****(BEL-BES 45°)**

Product number	hose I.D.		Dimension				
	in	mm	dash size	Pipe T	Type	drop H	Cut-off C
0750-03-06	3/16	4.8	03	6	L/S	25	38
0750-04-06	1/4	6.4	04	6	L/S	24	41
0750-04-08	1/4	6.4	04	8	L/S	25	43
0750-04-10	1/4	6.4	04	10	L/S	30	47
0750-05-10	5/16	7.9	05	10	L/S	30	49
0750-06-10	3/8	9.5	06	10	L/S	33	50
0750-06-12	3/8	9.5	06	12	L/S	29	52
0750S08-12	1/2	12.7	08	12	L	29	51
0750S08-15	1/2	12.7	08	15	L	29	55
0750S08-18	1/2	12.7	08	18	L	29	56
0750S10-18	5/8	15.9	10	18	L	29	56
0750S12-22	3/4	19	12	22	L	35	65

0035

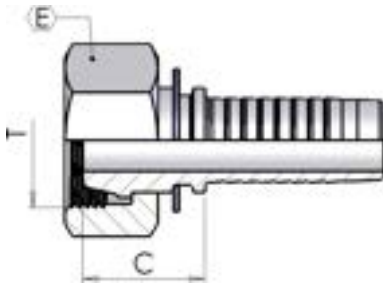

Metric Female 24° Seat Light Multiseal

(DKL)

Product number	hose I.D.		Dimension					Note
	in	mm	dash size	T	erm.	E	Cut-off C	
0035-03-12	3/16	4.8	03	M12-1.5	6	14	19	
0035-03-16	3/16	4.8	03	M16-1.5	10	19	18	
0035-04-14	1/4	6.4	04	M14-1.5	8	17	19	
0035-04-16	1/4	6.4	04	M16-1.5	10	19	19	
0035-05-16	5/16	7.9	05	M16-1.5	10	19	19	
0035-05-18	5/16	7.9	05	M18-1.5	12	22	21	
0035-06-16	3/8	9.5	06	M16-1.5	10	19	23	*
0035-06-18	3/8	9.5	06	M18-1.5	12	22	23	
0035-06-22	3/8	9.5	06	M22-1.5	15	27	22	
0035-08-22	1/2	12.7	08	M22-1.5	15	27	22	
0035-08-26	1/2	12.7	08	M26-1.5	18	32	24	
0035-10-26	5/8	15.9	10	M26-1.5	18	32	24	
0035-12-30	3/4	19	12	M30-2	22	36	29	
0035-16-36	1	25.4	16	M36-2	28	41	30	

*Rolled Nut

0135

**90° Metric Swept Elbow 24° Seat
Light Multiseal**

(DKL-90°)

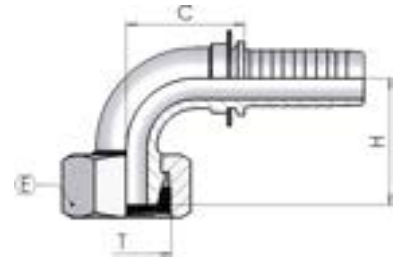

Product number	hose I.D.		Dimension					
	in	mm	dash size	T	erm.	E	drop H	Cut-off C
0135-04-14	1/4	6.4	04	M14-1.5	8	17	25	25
0135-04-16	1/4	6.4	04	M16-1.5	10	19	24	26
0135-05-16	5/16	7.9	05	M16-1.5	10	19	29	32
0135-06-18	3/8	9.5	06	M18-1.5	12	22	30	36
0135-08-22	1/2	12.7	08	M22-1.5	15	27	38	41

0400

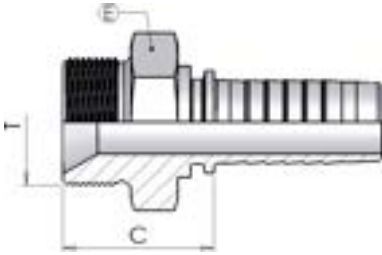

Metric Male 60° cone

(AGM)

Product number	hose I.D.		Dimension			
	in	mm	dash size	T	E	Cut-off C
0400-03-10	3/16	4.8	03	M10-1	14	19
0400-03-12	3/16	4.8	03	M12-1.5	17	25
0400-04-14	1/4	6.4	04	M14-1.5	19	26
0400-05-16	5/16	7.9	05	M16-1.5	22	26
0400-05-18	5/16	7.9	05	M18-1.5	24	26
0400-06-14	3/8	9.5	06	M14-1.5	19	26
0400-06-16	3/8	9.5	06	M16-1.5	22	26
0400-06-18	3/8	9.5	06	M18-1.5	24	27
0400-08-18	1/2	12.7	08	M18-1.5	24	28
0400-08-22	1/2	12.7	08	M22-1.5	27	30
0400-10-26	5/8	15.9	10	M26-1.5	32	32
0400-12-30	3/4	19	12	M30-1.5	36	36
0400-16-38	1	25.4	16	M38-1.5	46	37
0400-20-45	1.1/4	31.8	20	M45-1.5	55	39

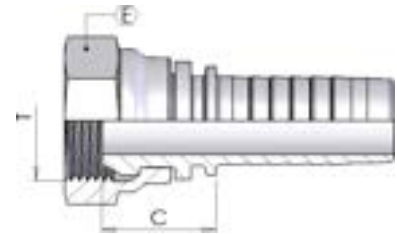
0100**Metric Female 60° cone****(DKM)**

Product number	hose I.D.		Dimension			
	in	mm	dash size	T	E	Cut-off C
0100-03-10	3/16	4.8	03	M10-1	14	15
0100-04-10	1/4	6.4	04	M10-1	14	15
0100-04-14	1/4	6.4	04	M14-1.5	19	17
0100-05-14	5/16	7.9	05	M14-1.5	19	17
0100-05-16	5/16	7.9	05	M16-1.5	22	19
0100-05-18	5/16	7.9	05	M18-1.5	24	19
0100-06-14	3/8	9.5	06	M14-1.5	19	17
0100-06-16	3/8	9.5	06	M16-1.5	22	19
0100-06-18	1/2	12.7	08	M18-1.5	24	19
0100-08-18	1/2	12.7	08	M18-1.5	24	20
0100-08-20	1/2	12.7	08	M20-1.5	27	22.5
0100-08-22	1/2	12.7	08	M22-1.5	27	22.5
0100-10-26	5/8	15.9	10	M26-1.5	32	25
0100-12-30	3/4	19	12	M30-1.5	36	26
0100-16-38	1	25.4	16	M38-1.5	46	33
0100-20-45	1.1/4	31.8	20	M45-1.5	50	34
0100-24-52	1.1/2	38.1	24	M52x1.5	60	35
0100-32-65	2	50.8	32	M65-2	75	31

0200

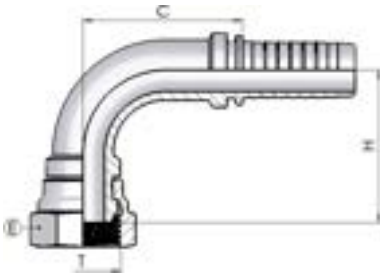

90° Metric Swept Elbow 60° cone

(DKM-90°)

Product number	hose I.D.		Dimension				
	in	mm	dash size	T	E	drop H	Cut-off C
0200-03-10	3/16	4.8	03	M10-1	14	23	22
0200-04-10	1/4	6.4	04	M10-1	14	25	24
0200-04-14	1/4	6.4	04	M14-1.5	19	26	24
0200-05-14	5/16	7.9	05	M14-1.5	19	31	29
0200-05-16	5/16	7.9	05	M16-1.5	22	35	29
0200-05-18	5/16	7.9	05	M18-1.5	24	35	29
0200-06-16	3/8	9.5	06	M16-1.5	22	34	33
0200-06-18	3/8	9.5	06	M18-1.5	24	34	33
0200-08-22	1/2	12.7	08	M22-1.5	27	40	41
0200-12-30	3/4	19	12	M30-1.5	36	36	57
0200-16-38	1	25.4	16	M38-1.5	46	71	70

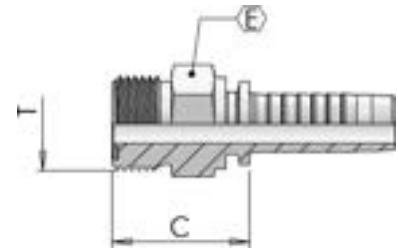
S350**ORFS Male****(AGO)**

Product number	hose I.D.		Dimension			
	in	mm	dash size	T	E	Cut-off C
S350-04-06-B0	1/4	6.4	04	9/16-18	17	23
S350-04-09-B0	1/4	6.4	04	11/16-16	19	21
S350-05-09-B0	5/16	7.9	05	11/16-16	19	26
S350-06-09-B0	3/8	9.5	06	11/16-16	19	26
S350-06-11-B0	3/8	9.5	6	13/16-16	22	29
S350-08-11-B0	1/2	12.7	08	13/16-16	22	29
S350-08-13-B0	1/2	12.7	08	1-14	27	34
S350-08-14-B0	1/2	12.7	08	1.3/16-12	32	35
S350-10-13-B0	5/8	15.9	10	1-14	27	33
S350-10-14-B0	5/8	15.9	10	1.3/16-12	32	35
S350-12-14-B0	3/4	19	12	1.3/16-12	32	36
S350-12-15-B0	3/4	19	12	1.7/16-12	38	36
S350-16-15-B0	1	25.4	16	1.7/16-12	38	37
S350-16-21-B0	1	25.4	16	1.11/16-12	46	38
S350-20-21-B0	1.1/4	31.8	20	1.11/16-12	46	39

- with plug and O-Ring

S050

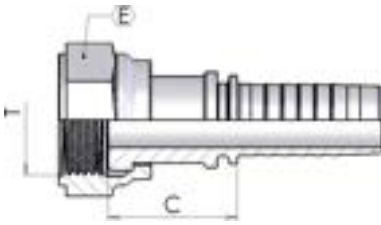

ORFS Female

(ORFS)

Product number	hose I.D.		Dimension				Note
	in	mm	dash size	T	E	Cut-off C	
S050-04-06	1/4	6.4	04	9/16-18	19	25	
S050-04-09	1/4	6.4	04	11/16-16	22	29	
S050-05-09	5/16	7.9	05	11/16-16	22	29	
S050-06-09	3/8	9.5	06	11/16-16	22	29	
S050-06-11	3/8	9.5	06	13/16-16	24	30	
S050-08-11	1/2	12.7	08	13/16-16	24	32	
S050-08-13	1/2	12.7	08	1-14	30	35	
S050-08-14	1/2	12.7	08	1.3/16-12	36	37	
S050-10-13	5/8	15.9	10	1-14	30	35	
S050-10-14	5/8	15.9	10	1.3/16-12	36	34	
S050-12-13	3/4	19	12	1-14	30	37	
S050-12-14	3/4	19	12	1.3/16-12	36	35	
S050-12-15	3/4	19	12	1.7/16-12	41	41	
S050-16-15	1	25.4	16	1.7/16-12	41	39	
S050-20-21	1.1/4	31.8	20	1.11/16-12	50	40	Slip on nut
S050-24-32	1.1/2	38.1	24	2-12	60	41	Slip on nut

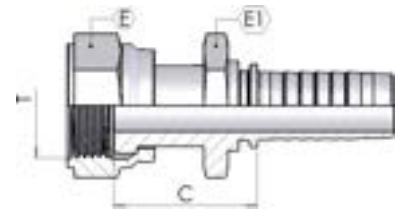
S05T**ORFS Female Back Hexagon****(ORFS)**

Product number	hose I.D.		Dimension				
	in	mm	dash size	T	E	E1	Cut-off C
S05T-04-06	1/4	6.4	04	9/16-18	17	15	30
S05T-06-09	3/8	9.5	06	11/16-16	22	17	34
S05T-08-11	1/2	12.7	08	13/16-16	24	19	37
S05T-10-13	5/8	15.9	10	1-14	30	24	41
S05T-12-14	3/4	19	12	1.3/16-12	36	30	42
S05T-16-15	1	25.4	16	1.7/16-12	41	36	50

S150

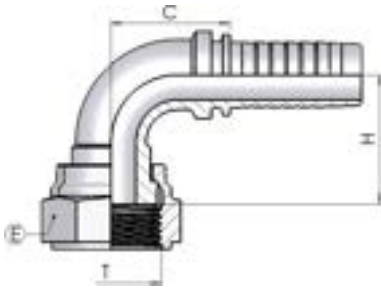

ORFS 90° Swept Elbow

(ORFS-90°)

Product number	hose I.D.		Dimension				Note
	in	mm	dash size	T	E	Cut-off C	
S150-04-06	1/4	6.4	04	9/16-18	19	25	
S150-04-09	1/4	6.4	04	11/16-16	22	25	
S150-05-09	5/16	7.9	05	11/16-16	22	29	
S150-06-09	3/8	9.5	06	11/16-16	22	33	
S150-06-11	3/8	9.5	06	13/16-16	24	33	
S150-08-11	1/2	12.7	08	13/16-16	24	43	
S150-08-13	1/2	12.7	08	1-14	30	42	
S150-08-14	1/2	12.7	08	1.3/16-12	36	42	
S150-10-13	5/8	15.9	10	1-14	30	44	
S150-10-14	5/8	15.9	10	1.3/16-12	36	42	Welded
S150-12-13	3/4	19	12	1-14	30	42	Welded
S150-12-14	3/4	19	12	1.3/16-12	36	57	
S150-12-15	3/4	19	12	1.7/16-12	41	56	
S150-16-15	1	25.4	16	1.7/16-12	41	67	
S150-16-21	1	25.4	20	1.11/16-12	50	62	Welded
S150-20-21	1.1/4	31.8	20	1.11/16-12	50	63	Welded
S150-24-32	1.1/2	38.1	24	2-12	60	80	Welded

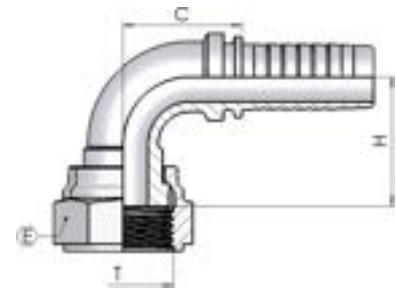
S15S**ORFS 90° Swept Elbow - ISO SHORT****(ORFS-90° S)**

Product number	hose I.D.		Dimension				
	in	mm	dash size	T	E	drop H	Cut-off C
S15S-04-06	1/4	6.4	04	9/16-18	19	21	25
S15S-06-09	3/8	9.5	06	11/16-16	22	23	33
S15S-08-11	1/2	12.7	08	13/16-16	24	29	43
S15S-08-13	1/2	12.7	08	1-14	30	32	39
S15S-10-13	5/8	15.9	10	1-14	30	32	47
S15S-12-14	3/4	19	12	1.3/16-12	36	48	57
S15S-16-15	1	25.4	16	1.7/16-12	41	56	67

S250

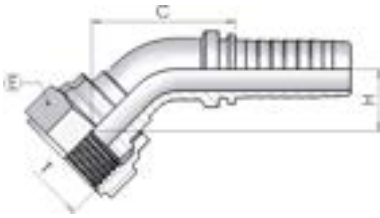

ORFS 45° Swept Elbow

(ORFS-45°)

Product number	hose I.D.		Dimension					Note
	in	mm	dash size	T	E	drop H	Cut-off C	
S250-04-06	1/4	6.4	04	9/16-18	19	14	40	
S250-04-09	1/4	6.4	04	11/16-16	22	14	38	
S250-05-09	5/16	7.9	05	11/16-16	22	14	44	
S250-06-09	3/8	9.5	06	11/16-16	22	17	52	
S250-06-11	3/8	9.5	06	13/16-16	24	18	51	
S250-08-11	1/2	12.7	08	13/16-16	24	20	62	
S250-08-13	1/2	12.7	08	1-14	30	23	64	
S250-08-14	1/2	12.7	08	1.3/16-12	36	17	44	Welded
S250-10-13	5/8	15.9	10	1-14	30	22	67	
S250-10-14	5/8	15.9	10	1.3/16-12	36	18	44	Welded
S250-12-13	3/4	19	12	1-14	30	15	40	Welded
S250-12-14	3/4	19	12	1.3/16-12	36	23	84	
S250-12-15	3/4	19	12	1.7/16-12	41	26	84	
S250-16-15	1	25.4	16	1.7/16-12	41	27	78	
S250-20-21	1.1/4	31.8	20	1.11/16-12	50	44	125	Welded
S250-24-32	1.1/2	38.1	24	2-12	60	29	78	Welded

1260

Straight SAE Flange 3000 PSI

(SFL)

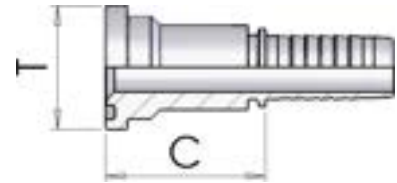

Product number	hose I.D.		Dimension				Note
	in	mm	dash size	T Flange	mm	Cut-off C	
1260-08-08	1/2	12.7	08	1/2	30,2	45	
1260-08-12	1/2	12.7	08	3/4	38.1	50	
1260-10-08	5/8	15.9	10	1/2	30,2	45	
1260-10-10	5/8	15.9	10	5/8	34	56	*
1260-10-12	5/8	15.9	10	3/4	38.1	49	
1260-12-12	3/4	19	12	3/4	38.1	50	
1260-12-16	3/4	19	12	1	44.5	53	
1260-16-16	1	25.4	16	1	44.5	54	
1260-16-20	1	25.4	16	1.1/4	50.8	57	
1260-20-20	1.1/4	31.8	20	1.1/4	50.8	59	
1260-20-24	1.1/4	31.8	20	1.1/2	60.3	62	
1260-24-24	1.1/2	38.1	24	1.1/2	60.3	62	
1260-24-32	1.1/2	38.1	24	2	71.4	67	
1260-32-32	2	50.8	32	2	71.4	68	
1260-32-40	2	50.8	32	2.1/2	84.1	76	
1260-40-40	2.1/2	63,5	40	2.1/2	84	76	
1260-48-48	3	76,2	48	3	102	63	

1060

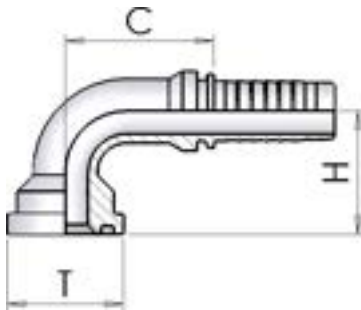

90° SAE Flange 3000 PSI

(SFL 90°)

Product number	hose I.D.		Dimension				
	in	mm	dash size	T Flange	mm	drop H	Cut-off C
1060-08-08	1/2	12.7	08	1/2	30,2	39	39
1060-08-12	1/2	12.7	08	3/4	38.1	44	42
1060-10-08	5/8	15.9	10	1/2	30,2	42	45
1060-10-12	5/8	15.9	10	3/4	38.1	47	45
1060-12-12	3/4	19	12	3/4	38.1	51	58
1060-12-16	3/4	19	12	1	44.5	55	56
1060-16-16	1	25.4	16	1	44.5	65	70
1060-16-20	1	25.4	16	1.1/4	50.8	70	67
1060-16-24	1	25.4	16	1.1/2	60.3	71	72
1060-20-16	1.1/4	31.8	20	1	44.5	73	83
1060-20-20	1.1/4	31.8	20	1.1/4	50.8	79	85
1060-20-24	1.1/4	31.8	20	1.1/2	60.3	81	85
1060-24-24	1.1/2	38.1	24	1.1/2	60.3	89	101
1060-24-32	1.1/2	38.1	24	2	71.4	90	102
1060-32-32	2	50.8	32	2	71.4	113	134

1160

45° SAE Flange 3000 PSI

(SFL 45°)

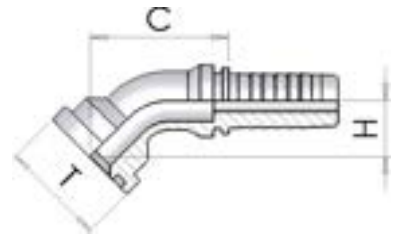

Product number	hose I.D.		Dimension				
	in	mm	dash size	T Flange	mm	drop H	Cut-off C
1160-08-08	1/2	12.7	08	1/2	30.2	22	62
1160-08-12	1/2	12.7	08	3/4	38.1	25	67
1160-12-12	3/4	19	12	3/4	38.1	25	69
1160-12-16	3/4	19	12	1	44.5	30	88
1160-16-16	1	25.4	16	1	44.5	29	82
1160-20-20	1.1/4	31.8	20	1.1/4	50.8	38	102
1160-20-24	1.1/4	31.8	20	1.1/2	60.3	39	106
1160-24-24	1.1/2	38.1	24	1.1/2	60.3	44	114
1160-24-32	1.1/2	38.1	24	2	71.4	40	115
1160-32-32	2	50.8	32	2	71.4	58	135

FS3L

90° SAE Flange 3000 Psi - Long Drop

(SFL 90° L)

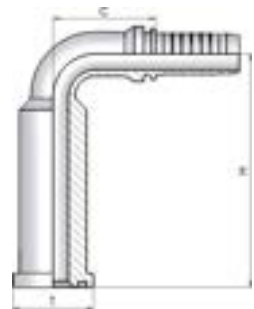

Product number	hose I.D.		Dimension				
	in	mm	dash size	T Flange	mm	drop H	Cut-off C
FS3L-12-12	3/4	19	12	3/8	38.1	123	56
FS3L-16-16	1	25.4	16	1	44.5	127	70
FS3L-20-20	1.1/4	31.8	20	1.1/4	50.8	178	85

S003

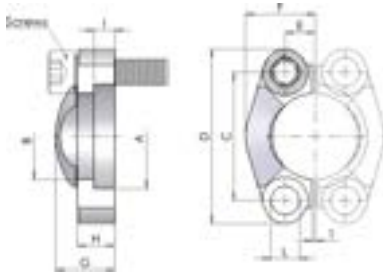

Cut Split Flanges - 3000 psi

Product number	SAE	Dimension									
	size	A	B	C	D	E	F	G	H	I	L
S003-08	1/2"	30.96	24.3	38.1	54	8.7	22.8	19	13	6.2	8.8
S003-12	3/4"	38.89	32.1	47.6	65	11.1	25.9	22	14	6.2	10.8
S003-16	1"	45.24	38.5	52.4	70	13.1	29.2	24	16	7.5	10.8
S003-20	1.1/4"	51.59	43.7	58.7	79	15.1	36.3	22	14	7.5	12
S003-24	1.1/2"	61.09	50.8	69.9	94	17.9	41.1	25	16	7.5	13.5
S003-32	2"	72.24	62.7	77.8	102	21.4	48.2	26	16	9	13.5
S003-40	2.1/2"	84.94	74.9	88.9	114	25.4	54.1	38	19	9	13.5

This product is sold in pairs

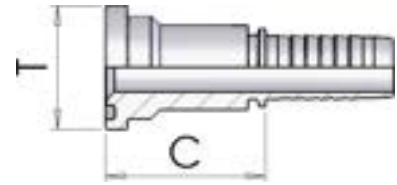
1310**Straight SAE Flange 6000 PSI****(SFS)**

Product number	hose I.D.		Dimension			
	in	mm	dash size	T Flange	mm	Cut-off C
1310-08-08	1/2	12.7	08	1/2	31,8	46
1310-08-12	1/2	12.7	08	3/4	41.3	53
1310-10-12	5/8	15.9	10	3/4	41.3	53
1310-12-12	3/4	19	12	3/4	41.3	54
1310-12-16	3/4	19	12	1	47.6	60
1310-16-16	1	25.4	16	1	47.6	61
1310-16-20	1	25.4	16	1.1/4	54	68
1310-20-20	1.1/4	31.8	20	1.1/4	54	70
1310-20-24	1.1/4	31.8	20	1.1/2	63.5	76
1310-24-24	1.1/2	38.1	24	1.1/2	63.5	76
1310-24-32	1.1/2	38.1	24	2	79.4	85
1310-32-32	2	50.8	32	2	79.4	85

1110

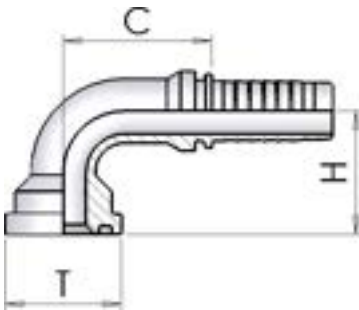

90° SAE Flange 6000 PSI

(SFS 90°)

Product number	hose I.D.		Dimension				
	in	mm	dash size	T Flange	mm	drop H	Cut-off C
1110-08-08	1/2	12.7	08	1/2	31.8	39	39
1110-08-12	1/2	12.7	08	3/4	41.3	48	39
1110-10-08	5/8	15.9	10	1/2	31.8	42	45
1110-10-12	5/8	15.9	10	3/4	41.3	52	44
1110-12-12	3/4	19	12	3/4	41.3	55	56
1110-12-16	3/4	19	12	1	47.6	63	56
1110-16-12	1	25.4	16	3/4	41.3	64	68
1110-16-16	1	25.4	16	1	47.6	69	70
1110-16-20	1	25.4	16	1.1/4	54	74	71
1110-20-20	1.1/4	31.8	20	1.1/4	54	83	97
1110-20-24	1.1/4	31.8	20	1.1/2	63.5	93	97
1110-24-24	1.1/2	38.1	24	1.1/2	63.5	103	100
1110-32-32	2	50.8	32	2	79.4	136	125

1210

45° SAE Flange 6000 PSI

(SFS 45°)

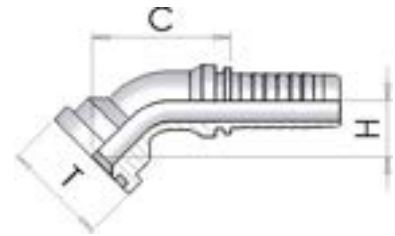

Product number	hose I.D.		Dimension				
	in	mm	dash size	T Flange	mm	drop H	Cut-off C
1210-08-08	1/2	12.7	08	1/2	31.8	22	62
1210-08-12	1/2	12.7	08	3/4	41.3	28	69
1210-10-08	5/8	15.9	10	1/2	31.8	21	66
1210-10-12	5/8	15.9	10	3/4	41.3	27	75
1210-12-12	3/4	19	12	3/4	41.3	28	74
1210-12-16	3/4	19	12	1	47.6	32	90
1210-16-12	1	25.4	16	3/4	41.3	29	94
1210-16-16	1	25.4	16	1	47.6	34	86
1210-16-20	1	25.4	16	1.1/4	54	37	90
1210-20-20	1.1/4	31.8	20	1.1/4	54	41	111
1210-20-24	1.1/4	31.8	20	1.1/2	63.5	48	118
1210-24-24	1.1/2	38.1	24	1.1/2	63.5	50	122
1210-32-32	2	50.8	32	2	79.4	58	151

FS6L

90° SAE Flange 6000 PSI - Long Drop

(SFS 90° L)

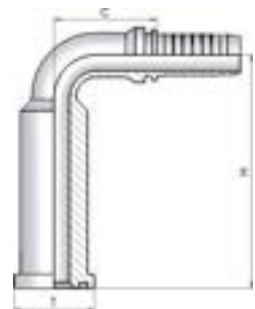

Product number	hose I.D.		Dimension				
	in	mm	dash size	T Flange	mm	drop H	Cut-off C
FS6L-08-08	1/2	12.7	08	1/2	32	75	40
FS6L-12-12	3/4	19	12	3/4	41.3	126	56
FS6L-16-16	1	25.4	16	1	47.6	132	70
FS6L-20-20	1.1/4	31.8	20	1.1/4	54	185	82

S006

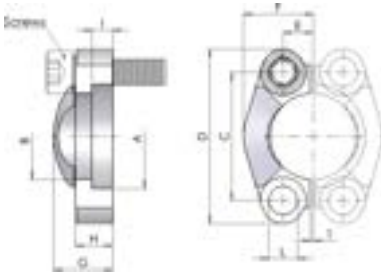

Cut Split Flanges - 6000 psi

Product number	SAE	Dimension									
	size	A	B	C	D	E	F	G	H	I	L
S006-08	1/2"	32.54	24.6	40.5	56	9.1	23.6	22	16	7.2	8.8
S006-12	3/4"	42.06	32.5	50.8	71	11.9	30	28	19	8.3	11
S006-16	1"	48.41	38.9	57.2	81	13.9	34.8	33	24	9	13
S006-20	1 1/4"	54.76	44.5	66.7	95	15.9	38.6	38	27	9.8	15
S006-24	1 1/2"	64.29	51.6	79.4	113	18.3	47.5	43	30	12.1	17
S006-32	2"	80.16	67.6	96.8	133	22.2	56.9	52	37	12.1	21

This product is sold in pairs

130S

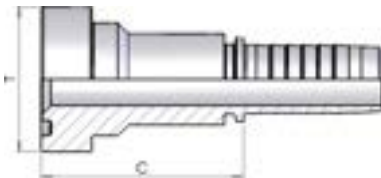

Straight 'CAT' Flange

(SFC)

Product number	hose I.D.		Dimension			
	in	mm	dash size	T Flange	mm	Cut-off C
130S-12-12	3/4	19	12	3/4	41.3	58
130S-12-16	3/4	19	12	1	47.6	64
130S-16-16	1	25.4	16	1	47.6	65
130S-16-20	1	25.4	16	1.1/4	54	73
130S-20-20	1.1/4	31.8	20	1.1/4	54	74
130S-24-24	1.1/2	38.1	24	1.1/2	63.5	80

110S

90° 'CAT' Flange

(SFC 90°)

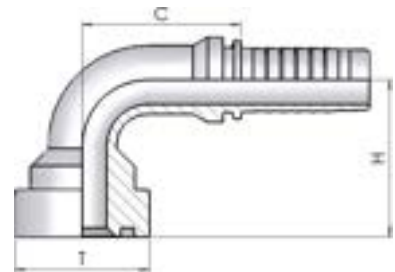

Product number	hose I.D.		Dimension				
	in	mm	dash size	T Flange	mm	drop H	Cut-off C
110S-12-12	3/4	19	12	3/4	41.3	62	56
110S-12-16	3/4	19	12	1	47.6	65	56
110S-16-16	1	25.4	16	1	47.6	74	78
110S-16-20	1	25.4	16	1.1/4	54	80	78
110S-20-20	1.1/4	31.8	20	1.1/4	54	90	97
110S-20-24	1.1/4	31.8	20	1.1/2	63.5	95	96
110S-24-24	1.1/2	38.1	24	1.1/2	63.5	104	115

120S

45° 'CAT' Flange

(SFC 45°)

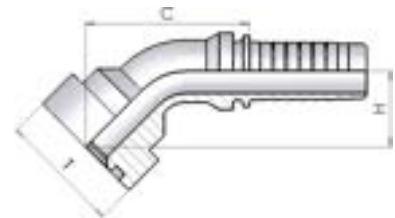

Product number	hose I.D.		Dimension				
	in	mm	dash size	T Flange	mm	drop H	Cut-off C
120S-12-12	3/4	19	12	3/4	41.3	32	88
120S-12-16	3/4	19	12	1	47.6	37	93
120S-16-16	1	25.4	16	1	47.6	37	90
120S-16-20	1	25.4	16	1.1/4	54	44	122
120S-20-20	1.1/4	31.8	20	1.1/4	54	43	114
120S-20-24	1.1/4	31.8	20	1.1/2	63.5	48	119
120S-24-24	1.1/2	38.1	24	1.1/2	63.5	52	172

1250

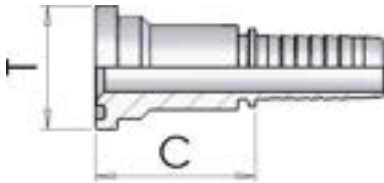

Flangia Komatsu dritta SAE 3000 PSI

(SFL)

Product number	hose I.D.		Dimension			
	in	mm	dash size	T Flange	mm	Cut-off C
1250-10-10	5/8	15.9	10	5/8	34	56

1050

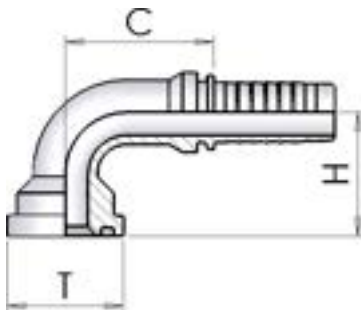

Komatsu Flange 90°

(JIS-KF)

Product number	hose I.D.		Dimension					Note
	in	mm	dash size	T Flange	mm	drop H	Cut-off C	
1050-10-10	5/8	15.9	10	5/8	34	47	58	Welded

1150

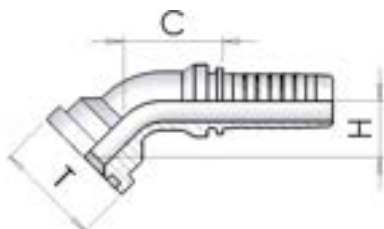

Flangia Komatsu 45° SAE 3000 PSI

(SFL 45°)

Product number	hose I.D.		Dimension					Note
	in	mm	dash size	T Flange	mm	drop H	Cut-off C	
1150-10-10	5/8	15.9	10	5/8	34	54	23	Welded

0940

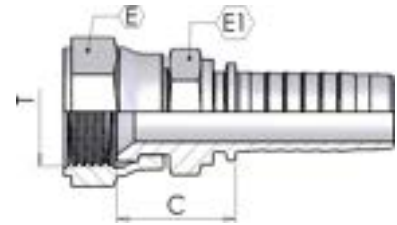
JIS Female 60° Cone (Komatsu)**(JIS-K)**

Product number	hose I.D.		Dimension				
	in	mm	dash size	T	E	E1	Cut-off C
0940-04-14	1/4	6.4	04	M14x1,5	19	17	22
0940-05-16	5/16	7.9	05	M16x1,5	22	17	22
0940-06-14	3/8	9.5	06	M14x1,5	19	17	22
0940-06-16	3/8	9.5	06	M16x1,5	22	19	22
0940-06-18	3/8	9.5	06	M18x1,5	24	19	21
0940-08-22	1/2	12.7	08	M22x1,5	27	22	27
0940-08-24	1/2	12.7	08	M24x1,5	30	27	25
0940-10-24	5/8	15.9	10	M24x1,5	30	27	26
0940-12-30	3/4	19	12	M30x1,5	36	30	30
0940-16-33	1	25.4	16	M33x1,5	41	36	33
0940-20-36	1.1/4	31.8	20	M36x1,5	46	46	37
0940-24-42	1.1/2	38.1	24	M42x1,5	50	50	38

0990S

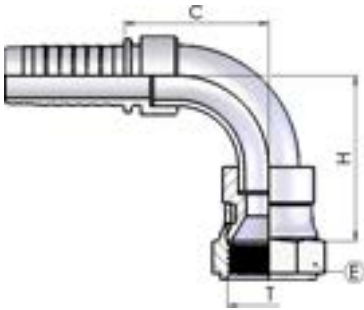

90° JIS Swept Elbow (Komatsu) - welded

(JIS-K 90°)

Product number	hose I.D.		Dimension				
	in	mm	dash size	T	E	drop H	Cut-off C
0990S04-14	1/4	6.4	04	M14x1,5	19	35	38
0990S05-16	5/16	7.9	05	M16x1,5	22	30	27
0990S06-14	3/8	9.5	06	M14x1,5	19	33	31
0990S06-18	3/8	9.5	06	M18x1,5	24	33	31
0990S08-22	1/2	12.7	08	M22x1,5	27	39	33
0990S10-24	5/8	15.9	10	M24x1,5	30	48	42
0990S12-30	3/4	19	12	M30x1,5	36	43	48
0990S16-33	1	25.4	16	M33x1,5	41	62	57

0930

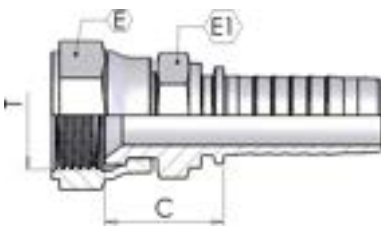

JIS Female 60° cone (Toyota)

(JIS-T)

Product number	hose I.D.		Dimension				
	in	mm	dash size	T	E	E1	Cut-off C
0930-04-04	1/4	6.4	04	1/4-19	19	17	20
0930-06-06	3/8	9.5	06	3/8-19	22	19	22
0930-08-08	1/2	12.7	08	1/2-14	27	22	26
0930-12-12	3/4	19	12	3/4-14	32	30	29
0930-16-16	1	25.4	16	1-11	38	36	31
0930-20-20	1.1/4	31.8	20	1.1/4-11	50	46	35
0930-24-24	1.1/2	38.1	24	1.1/2-11	55	50	28

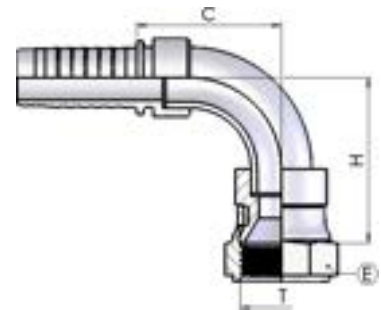
0980S**90° JIS Swept Elbow (Toyota) -
welded****(JIS-T 90°)**

Product number	hose I.D.		Dimension				
	in	mm	dash size	T	E	drop H	Cut-off C
0980S04-04	1/4	6.4	04	1/4-19	19	35	38
0980S06-06	3/8	9.5	06	3/8-19	22	30	27
0980S08-08	1/2	12.7	08	1/2-14	27	39	33
0980S12-12	3/4	19	12	3/4-14	32	55	48
0980S16-16	1	25.4	16	1-11	38	62	57

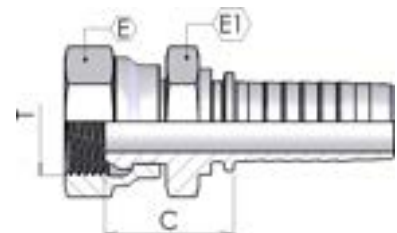
0920**JIS Female 60° cone (Nissan)****(JIS-N)**

Product number	hose I.D.		Dimension				
	in	mm	dash size	T	E	E1	Cut-off C
0920-04-04	1/4	6.4	04	1/4-19	19	19	23
0920-06-06	3/8	9.5	06	3/8-19	22	22	28
0920-08-08	1/2	12.7	08	1/2-14	27	27	27

0030

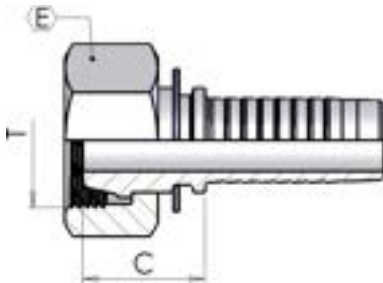

Metric Female 24° Cone French Type

(DKF)

Product number	hose I.D.		Dimension			
	in	mm	dash size	T	E	Cut-off C
0030-05-20	5/16	7.9	05	M20-1.5	24	25
0030-06-20	3/8	9.5	06	M20-1.5	24	26
0030-08-24	1/2	12.7	08	M24-1.5	30	28
0030-10-30	5/8	15.9	10	M30-1.5	36	25
0030-12-30	3/4	19	12	M30-1.5	36	26
0030-12-36	3/4	19	12	M36-1.5	46	29
0030-16-45	1	25.4	16	M45-1.5	55	30
0030-20-52	1.1/4	31.8	20	M52-1.5	65	34

FK50

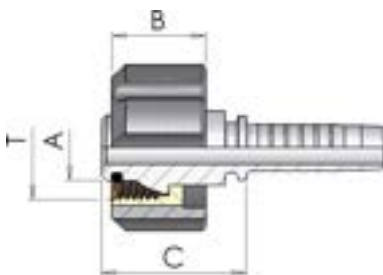

K' Female

Product number	hose I.D.		Dimension				
	in	dash size	mm	T	A	B	Cut-off C
FK50-04-22	1/4	04	6.4	M22-1.5	14	20	31
FK50-05-22	5/16	05	7.9	M22-1.5	14	20	31
FK50-06-22	3/8	06	9.5	M22-1.5	14	20	31
FK50-04022	1/4	04	6.4	M22-1.5	14	27	31
FK50-05022	5/16	05	7.9	M22-1.5	14	27	31
FK50-06022	3/8	06	9.5	M22-1.5	14	27	31

FN50

'K' Male (for gun) - Diameter 10

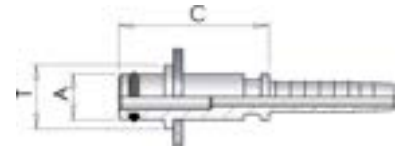

Product number	hose I.D.		Dimension	
	in	mm	dash size	A
FN50-04-22	1/4	6.4	04	10
FN50-05-22	5/16	7.9	05	10
FN50-06-22	3/8	9.5	06	10

FN51

'K' Male (for gun) - Diameter 11

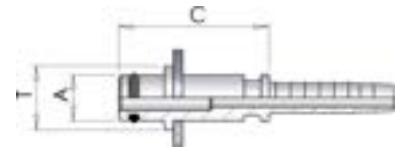

Product number	hose I.D.		Dimension		
	in	mm	dash size	A	Cut-off C
FN51-04-22	1/4	6.4	04	11	33
FN51-05-22	5/16	7.9	05	11	33

1400

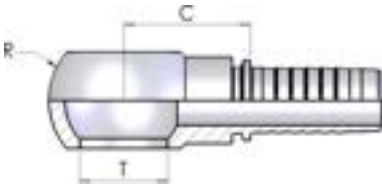

BSP Banjo

RNR

Product number	hose I.D.		Dimension				
	in	mm	dash size	hole T	mm	R	Cut-off C
1400-03-02	3/16	4.8	03	1/8-28	10.2	17	19
1400-03-04	3/16	4.8	03	1/4-19	13.3	24	26
1400-04-02	1/4	6.4	04	1/8-28	10.2	17	25
1400-04-04	1/4	6.4	04	1/4-19	13.3	24	26
1400-04-06	1/4	6.4	04	3/8-19	17	28	26
1400-05-04	5/16	7.9	05	1/4-19	13.3	24	26
1400-05-06	5/16	7.9	05	3/8-19	17	28	26
1400-06-04	3/8	9.5	06	1/4-19	13.3	24	26
1400-06-06	3/8	9.5	06	3/8-19	17	28	26
1400-06-08	3/8	9.5	06	1/2-14	21.2	36	31
1400-08-06	1/2	12.7	08	3/8-19	17	28	27
1400-08-08	1/2	12.7	08	1/2-14	21.2	36	31
1400-08-12	1/2	12.7	08	3/4-14	26.5	45	38
1400-10-12	5/8	15.9	10	3/4-14	26.5	45	38
1400-12-12	3/4	19	12	3/4-14	26.5	45	38
1400-12-16	3/4	19	12	1-11	33.5	58	49
1400-16-16	1	25.4	16	1-11	33.5	58	50

1600

Double BSP Perforded Bolt

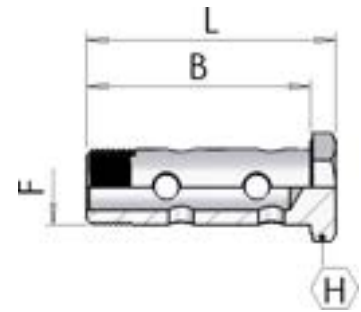

Product number	Dimension			
	F	B	L	H
1600-04-04	1/4-19	43	49	19
1600-06-06	3/8-19	49	57	22
1600-08-08	1/2-14	62	70	27
1600-12-12	3/4-14	78	87	32
1600-16-16	1-11	98	109	41

1600-00

BSP Perforded Bolt

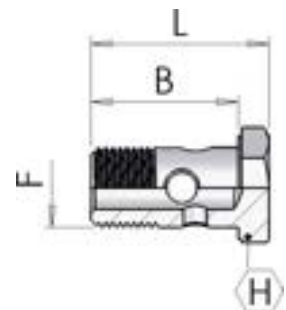

Product number	Dimension			
	F	B	L	H
1600-00-02	1/8-28	19	24	14
1600-00-04	1/4-19	29	34	19
1600-00-06	3/8-19	33	41	22
1600-00-08	1/2-14	38	46	27
1600-00-12	3/4-14	47	56	32
1600-00-16	1-11	58	69	41

1350

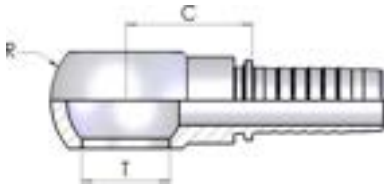

Metric Banjo

RNM

Product number	hose I.D.		Dimension				
	in	mm	dash size	hole T	mm	R	Cut-off C
1350-03-10	3/16	4.8	03	M10-1	10.2	17	25
1350-03-12	3/16	4.8	03	M12-1.5	12.2	20	22
1350-04-10	1/4	6.4	04	M10-1	10.2	17	25
1350-04-12	1/4	6.4	04	M12-1.5	12.2	20	22
1350-04-14	1/4	6.4	04	M14-1.5	14.2	24	26
1350-05-14	5/16	7.9	05	M14-1.5	14.2	24	26
1350-05-16	5/16	7.9	05	M16-1.5	16.2	28	26
1350-05-18	5/16	7.9	05	M18-1.5	18.2	32	29
1350-06-14	3/8	9.5	06	M14-1.5	14.2	24	26
1350-06-16	3/8	9.5	06	M16-1.5	16.2	28	26
1350-06-18	3/8	9.5	06	M18-1.5	18.2	32	29
1350-06-22	3/8	9.5	06	M22-1.5	22.2	36	31
1350-08-16	1/2	12.7	08	M16-1.5	16.2	28	27
1350-08-18	1/2	12.7	08	M18-1.5	18.2	32	29
1350-08-22	1/2	12.7	08	M22-1.5	22.2	36	31
1350-10-22	5/8	15.9	10	M22-1.5	22.2	36	31
1350-10-26	5/8	15.9	10	M26-1.5	26.5	45	38
1350-12-22	3/4	19	12	M22-1.5	22.2	36	32
1350-12-26	3/4	19	12	M26-1.5	26.2	46	38
1350-16-30	1	25.4	16	M30-2	30.2	54	45

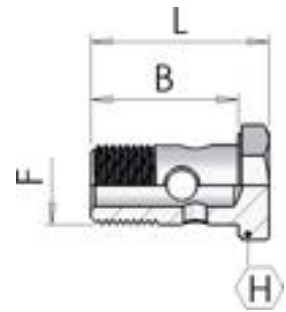
1650**Metric perfored bolt**

Product number	Dimension			
	F	B	L	H
1650-00-10	M10-1	19	24	14
1650-00-12	M12-1.5	26	31	17
1650-00-14	M14-1.5	29	34	19
1650-00-16	M16-1.5	33	41	22
1650-00-18	M18-1.5	37	44	24
1650-00-22	M22-1.5	38	46	27
1650-00-26	M26-1.5	47	56	32
1650-00-30	M30-1.5	58	68	36

D050**Hose Junction**

Product number	hose I.D.		Dimension	
	in	mm	dash size	Cut-off C
D050-03	3/16	4.8	03	17
D050-04	1/4	6.4	04	22
D050-05	5/16	7.9	05	22
D050-06	3/8	9.5	06	22
D050-08	1/2	12.7	08	23
D050-10	5/8	15.9	10	18
D050-12	3/4	19	12	19
D050-16	1	25.4	16	21
D050-20	1.1/4	31.8	20	24
D050-24	1.1/2	38.1	24	24
D050-32	2	50.8	32	26

GS00

Weldable Fitting

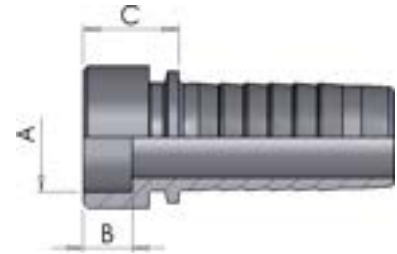

Product number	hose I.D.		Dimension			
	in	mm	dash size	A	B	Cut-off C
GS00-03-08	3/16	4.8	03	08	6	12
GS00-04-06	1/4	6.4	04	06	6	14
GS00-04-08	1/4	6.4	04	08	6	14
GS00-04-10	1/4	6.4	04	10	6	15
GS00-04-12	1/4	6.4	04	12	7	17
GS00-05-08	5/16	7.9	05	08	6	14
GS00-05-10	5/16	7.9	05	10	6	14
GS00-05-12	5/16	7.9	05	12	6	14
GS00-06-06	3/8	9.5	06	06	6	15
GS00-06-08	3/8	9.5	06	08	6	15
GS00-06-10	3/8	9.5	06	10	6	14
GS00-06-12	3/8	9.5	06	12	7	15
GS00-06-15	3/8	9.5	06	15	7	14
GS00-08-12	1/2	12.7	08	12	7	15
GS00-08-14	1/2	12.7	08	14	8	15
GS00-08-15	1/2	12.7	08	15	7	15
GS00-08-16	1/2	12.7	08	16	7	15
GS00-08-20	1/2	12.7	08	20	9	18
GS00-10-16	5/8	15.9	10	16	8	16
GS00-10-18	5/8	15.9	10	18	8	16
GS00-10-20	5/8	15.9	10	20	9	18
GS00-12-16	3/4	19	12	16	8	16
GS00-12-18	3/4	19	12	18	8	16
GS00-12-20	3/4	19	12	20	9	18
GS00-12-22	3/4	19	12	22	9	18
GS00-12-25	3/4	19	12	25	9	19
GS00-16-25	1	25.4	16	25	9	19
GS00-16-30	1	25.4	16	30	9	20
GS00-20-35	1.1/4	31.8	20	35	11	23

without zinc plating

N Tail

in!



0NI4



Swaged Ferrule 4WS (no skive)

90

0NI6



Swaged Ferrule (no skive)

90



0370N



NPTF Male 60° cone

91



0350N



BSP Male Parallel 60° cone

91

0050N 0051N



BSP Female 60° Cone

92

0150N 0151N



BSP 90° Swept elbow 60° cone

93

0250N 0251N



BSP 45° Swept Elbow 60° Cone

94



0850N



JIC Male 74° cone

95

0900N 0901N



JIC Female 74° Cone-Double Hexagon

96

0950N 0951N



JIC 90° Swept Elbow 74° cone

97

095SN



JIC 90° Swept Elbow 74° cone - ISO SHORT

97

1000N 1001N



JIC 45° Swept Elbow 74°

98



0500N



Metric Male 24° Seat
Light

99

0085N



Metric Female 24° Seat
Light

100

0185N



90° Metric Swept Elbow
24° Seat Light

100

0285N



45° Metric Swept Elbow
24° Seat Light

101



0450N



Metric Male 24° Seat
Heavy

101

0084N



Metric Female 24° Seat
Heavy

102

0184N



90° Metric Swept Elbow
24° Seat Heavy

102

0284N



45° Metric Swept Elbow
24° Seat Heavy

103



S350N



ORFS Male

104

S05TN



ORFS Female Back
Hexagon

104

S15SN



ORFS 90° Swept Elbow -
ISO SHORT

105

S250N



ORFS 45° Swept Elbow

105



S150N



ORFS 90° Swept Elbow

106



1250N



Straight SAE Flange
3000 PSI

107

1050N



90° SAE Flange 3000 PSI

107

1150N



45° SAE Flange 3000 PSI

108



1300N



Straight SAE Flange
6000 PSI

108

1100N



90° SAE Flange 6000 PSI

109

1200N



45° SAE Flange 6000 PSI

110



130SN



Straight 'CAT' Flange

110

110SN



90° 'CAT' Flange

111

120SN



45° 'CAT' Flange

112

ONI4

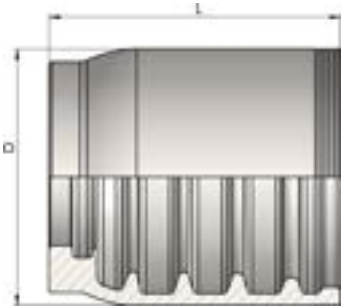

Swaged Ferrule 4WS (no skive)

Product number	hose I.D.		Dimension		skive	valid for
	in	mm	D	L	Length	-
ONI4-06	3/8	9.5	30.5	37	NO	SR-ISO
ONI4-08	1/2	12.7	33.5	37.5	NO	SR-ISO
ONI4-10	5/8	15.9	37.5	46	NO	SR-ISO
ONI4-12	3/4	19	44.5	50.5	NO	SR-ISO
ONI4-16	1	25.4	52.5	59.5	NO	SR-ISO
ONI4-20	1.1/4	31.8	60.5	70	NO	SR-ISO
ONI4-24	1.1/2	38.1	69.5	80	NO	SR-ISO

ONI6

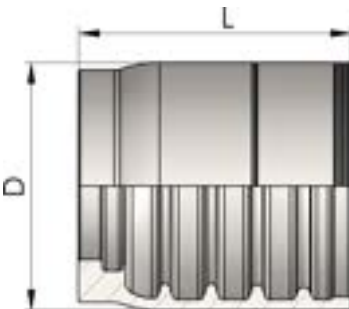

Swaged Ferrule (no skive)

Product number	hose I.D.		Dimension		skive	valid for
	in	mm	D	L	Length	-
ONI6-20	1.1/4	31.8	63.5	70	NO	SR-ISO
ONI6-24	1.1/2	38.1	72.5	80	NO	SR-ISO

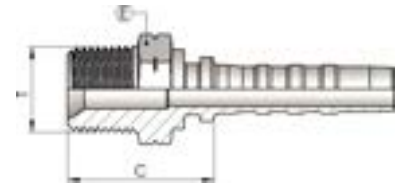
0370N**NPTF Male 60° cone****(AGN)**

Product number	hose I.D.		Dimension			
	in	mm	dash size	T	E	Cut-off C
0370N06-06	3/8	9.5	06	3/8-18	19	30
0370N06-08	3/8	9.5	06	1/2-14	22	36
0370N08-08	1/2	12.7	08	1/2-14	22	36
0370N12-12	3/4	19	12	3/4-14	27	39
0370N16-16	1	25.4	16	1-11.1/2	36	46
0370N20-20	1.1/4	31.8	20	1.1/4-11.1/2	46	50
0370N24-24	1.1/2	38.1	24	1.1/2-11.1/2	50	54

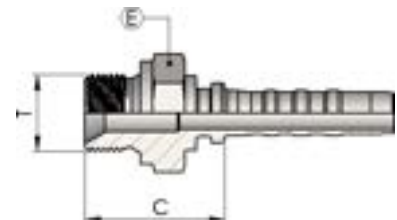
0350N**BSP Male Parallel 60° cone****(AGR)**

Product number	hose I.D.		Dimension			
	in	mm	dash size	T	E	Cut-off C
0350N06-06	3/8	9.5	06	3/8-19	22	31
0350N06-08	3/8	9.5	06	1/2-14	27	34
0350N08-08	1/2	12.7	08	1/2-14	27	34
0350N10-10	5/8	15.9	10	5/8-14	30	37
0350N10-12	5/8	15.9	10	3/4-14	32	37
0350N12-12	3/4	19	12	3/4-14	32	38
0350N12-16	3/4	19	12	1-11	41	41
0350N16-16	1	25.4	16	1-11	41	42
0350N16-20	1	25.4	16	1.1/4-11	50	46
0350N20-20	1.1/4	31.8	20	1.1/4-11	50	48
0350N24-24	1.1/2	38.1	24	1.1/2-11	55	51

0050N 0051N

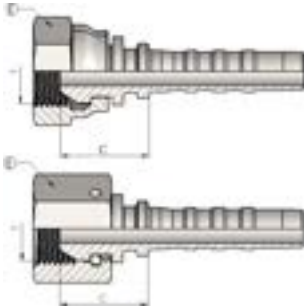

BSP Female 60° Cone

(DKR)

Product number	hose I.D.		Dimension				Note
	in	mm	dash size	T	E	Cut-off C	
0051N06-06	3/8	9.5	06	3/8-19	22	21	
0051N06-08	3/8	9.5	06	1/2-14	27	24	
0051N08-08	1/2	12.7	08	1/2-14	27	24	
0051N10-10	5/8	15.9	10	5/8-14	30	22	
0050N10-12	5/8	15.9	10	3/4-14	32	27	
0050N12-12	3/4	19	12	3/4-14	32	27	
0050N12-16	3/4	19	12	1-11	41	28	
0050N16-16	1	25.4	16	1-11	41	30	
0050N20-20	1.1/4	31.8	20	1.1/4-11	50	34	(*)
0050N20-24	1.1/4	31.8	20	1.1/2-11	55	36	(*)
0050N24-24	1.1/2	38.1	24	1.1/2-11	55	39	(*)

(*) - Femmina BSP con O-Ring.

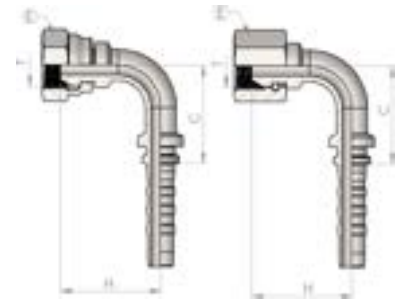

0150N 0151N**BSP 90° Swept elbow 60° cone**

Product number	hose I.D.		Dimension					Note
	in	mm	dash size	T	E	drop H	Cut-off C	
0151N06-06	3/8	9.5	06	3/8-19	22	35	33	
0151N06-08	3/8	9.5	06	1/2-14	27	40	31	
0151N08-08	1/2	12.7	08	1/2-14	27	41	39	
0151N10-10	5/8	15.9	10	5/8-14	30	43	44	
0150N10-12	5/8	15.9	10	3/4-14	32	50	45	
0150N12-12	3/4	19	12	3/4-14	32	57	59	
0150N16-16	1	25.4	16	1-11	41	70	78	
0150N16-20	1	25.4	16	1.1/4-11	50	76	77	(*)
0150N20-20	1.1/4	31.8	20	1.1/4-11	50	84	97	(*)
0150N24-24	1.1/2	38.1	24	1.1/2-11	55	104	110	(*)

(*) - BSP O-Ring Female



0250N 0251N

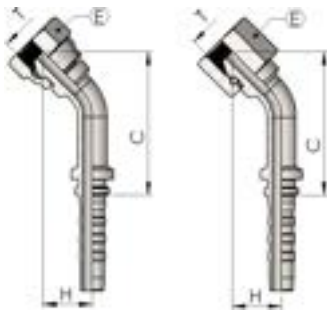

BSP 45° Swept Elbow 60° Cone

(DKR-45°)

Product number	hose I.D.		Dimension					Note
	in	mm	dash size	T	E	drop H	Cut-off C	
0251N06-06	3/8	9.5	06	3/8-19	22	19	54	
0251N06-08	3/8	9.5	06	1/2-14	27	21	57	
0251N08-08	1/2	12.7	08	1/2-14	27	24	66	
0251N10-10	5/8	15.9	10	5/8-14	30	23	70	
0250N10-12	5/8	15.9	10	3/4-14	32	27	74	
0250N12-12	3/4	19	12	3/4-14	32	28	88	
0250N16-16	1	25.4	16	1-11	41	38	116	
0250N16-20	1	25.4	16	1.1/4-11	50	33	70	(*)
0250N20-20	1.1/4	31.8	20	1.1/4-11	50	41	103	(*)
0250N24-24	1.1/2	38.1	24	1.1/2-11	55	54	172	(*)

(*) - BSP O-Ring Female

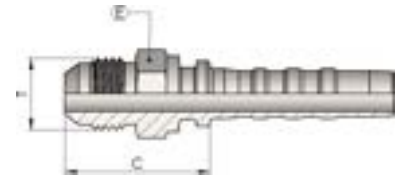

0850N**JIC Male 74° cone****(AGJ)**

Product number	hose I.D.		Dimension			
	in	mm	dash size	T	E	Cut-off C
0850N06-06	3/8	9.5	06	9/16-18	15	29
0850N06-08	3/8	9.5	06	3/4-16	19	32
0850N08-08	1/2	12.7	08	3/4-16	19	32
0850N08-10	1/2	12.7	08	7/8-14	24	36
0850N08-12	1/2	12.7	08	1.1/16-12	27	38
0850N10-10	5/8	15.9	10	7/8-14	24	37
0850N12-12	3/4	19	12	1.1/16-12	27	40
0850N16-16	1	25.4	16	1.5/16-12	34	45
0850N20-20	1.1/4	31.8	20	1.5/8-12	42	50
0850N24-24	1.1/2	38.1	24	1.7/8-12	55	52

0900N 0901N

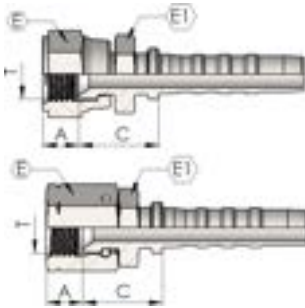

JIC Female 74° Cone- Double Hexagon

(DKJ)

Product number	hose I.D.		Dimension					
	in	mm	dash size	T	E	E1	Cut-off C	A
0901N06-06	3/8	9.5	06	9/16-18	19	17	26	9
0901N06-08	3/8	9.5	06	3/4-16	24	19	28	10.5
0901N08-08	1/2	12.7	08	3/4-16	24	22	28	10.5
0901N08-10	1/2	12.7	08	7/8-14	27	22	28	13
0900N08-12	1/2	12.7	08	1.1/16-12	32	27	33	13.5
0901N10-10	5/8	15.9	10	7/8-14	27	22	28	13
0900N12-12	3/4	19	12	1.1/16-12	32	27	34	13.5
0900N16-16	1	25.4	16	1.5/16-12	38	36	35	15.5
0900N20-20	1.1/4	31.8	20	1.5/8-12	50	46	42	16.5
0900N24-24	1.1/2	38.1	24	1.7/8-12	55	50	46	19

0950N 0951N

JIC 90° Swept Elbow 74° cone

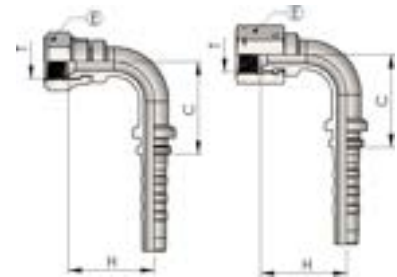

Product number	hose I.D.		Dimension				
	in	mm	dash size	T	E	drop H	Cut-off C
0951N06-06	3/8	9.5	06	9/16-18	19	32	31
0951N06-08	3/8	9.5	06	3/4-16	24	34	35
0951N08-08	1/2	12.7	08	3/4-16	24	41	41
0951N08-10	1/2	12.7	08	7/8-14	27	40	41
0950N08-12	1/2	12.7	08	1.1/16-12	32	43	39
0950N10-10	5/8	15.9	10	7/8-14	27	45	42
0950N12-12	3/4	19	12	1.1/16-12	32	54	56
0950N16-16	1	25.4	16	1.5/16-12	41	65	70
0950N20-20	1.1/4	31.8	20	1.5/8-12	50	85	82
0950N24-24	1.1/2	38.1	24	1.7/8-12	55	97	104

095SN

JIC 90° Swept Elbow 74° cone - ISO SHORT



Product number	hose I.D.		Dimension		
	in	mm	dash size	T	E
095SN06-06	3/8	9.5	06	9/16-18	19
095SN08-08	1/2	12.7	08	3/4-16	24
095SN10-10	5/8	15.9	10	7/8-14	27
095SN12-12*	3/4	19	12	1.1/16-12	32

*Thrust Wire Nut

1000N 1001N

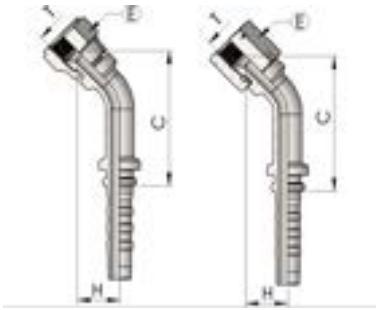

JIC 45° Swept Elbow 74°

(DKJ-45°)

Product number	hose I.D.		Dimension				
	in	mm	dash size	T	E	drop H	Cut-off C
1001N06-06	3/8	9.5	06	9/16-18	19	17	51
1001N06-08	3/8	9.5	06	3/4-16	24	19	51
1001N08-08	1/2	12.7	08	3/4-16	24	22	62
1001N08-10	1/2	12.7	08	7/8-14	27	23	64
1000N08-12	1/2	12.7	08	1.1/16-12	32	25	68
1001N10-10	5/8	15.9	10	7/8-14	27	24	68
1000N12-12	3/4	19	12	1.1/16-12	32	28	84
1000N16-16	1	25.4	16	1.5/16-12	41	32	83
1000N20-20	1.1/4	31.8	20	1.5/8-12	50	42	108
1000N24-24	1.1/2	38.1	24	1.7/8-12	55	49	156

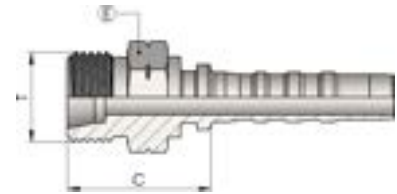
0500N**Metric Male 24° Seat Light****(CEL)**

Product number	hose I.D.		Dimension				
	in	mm	dash size	T	erm.	E	Cut-off C
0500N06-16	3/8	9.5	06	M16-1.5	10	17	23
0500N06-18	3/8	9.5	06	M18-1.5	12	19	24
0500N06-22	3/8	9.5	06	M22-1.5	15	22	25
0500N08-18	1/2	12.7	08	M18-1.5	12	19	25
0500N08-22	1/2	12.7	08	M22-1.5	15	22	26
0500N08-26	1/2	12.7	08	M26-1.5	18	27	27
0500N10-22	5/8	15.9	10	M22-1.5	15	22	26
0500N10-26	5/8	15.9	10	M26-1.5	18	27	27
0500N10-30	5/8	15.9	10	M30-2	22	30	32
0500N12-26	3/4	19	12	M26-1.5	18	27	28
0500N12-30	3/4	19	12	M30-2	22	30	33
0500N16-36	1	25.4	16	M36-2	28	36	32
0500N20-45	1.1/4	31.8	20	M45-2	35	46	36
0500N24-52	1.1/2	38.1	24	M52-2	42	55	38

0085N

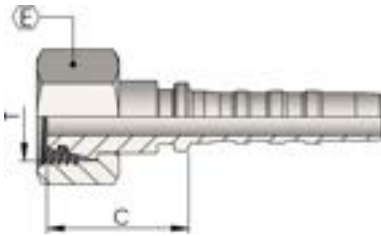

Metric Female 24° Seat Light

(DKOL)

Product number	hose I.D.		Dimension				
	in	mm	dash size	T	erm.	E	Cut-off C
0085N06-18	3/8	9.5	06	M18-1.5	12	22	27
0085N08-22	1/2	12.7	08	M22-1.5	15	27	30
0085N10-26	5/8	15.9	10	M26-1.5	18	32	31
0085N12-30	3/4	19	12	M30-2	22	36	31
0085N16-36	1	25.4	16	M36-2	28	41	32
0085N20-45	1.1/4	31.8	20	M45-2	35	50	43
0085N24-52	1.1/2	38.1	24	M52-2	42	60	46

0185N

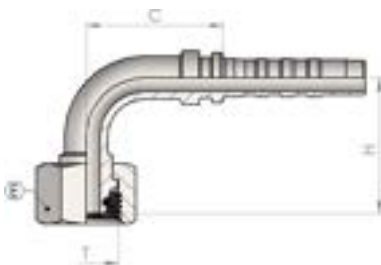

90° Metric Swept Elbow 24° Seat Light

(DKOL-90°)

Product number	hose I.D.		Dimension					
	in	mm	dash size	T	erm.	E	drop H	Cut-off C
0185N06-18	3/8	9.5	06	M18-1.5	12	22	33	34
0185N08-22	1/2	12.7	08	M22-1.5	15	27	41	41
0185N10-26	5/8	15.9	10	M26-1.5	18	32	44	44
0185N12-30	3/4	19	12	M30-2	22	36	52	58
0185N16-36	1	25.4	16	M36-2	28	41	62	72
0185N20-45	1.1/4	31.8	20	M45-2	35	50	73	63
0185N24-52	1.1/2	38.1	24	M52-2	42	60	83	81

0285N

45° Metric Swept Elbow 24° Seat Light

(DKOL-45°)

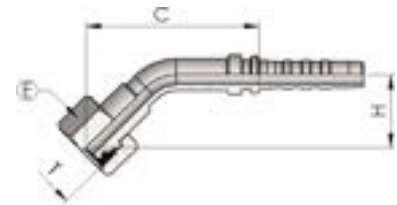

Product number	hose I.D.		Dimension					Cut-off C
	in	mm	dash size	T	erm.	E	H	
0285N06-18	3/8	9.5	06	M18-1.5	12	22	19	52
0285N08-22	1/2	12.7	08	M22-1.5	15	27	21	63
0285N10-26	5/8	15.9	10	M26-1.5	18	32	23	68
0285N16-36	1	25.4	16	M36-2	28	41	29	82
0285N20-45	1.1/4	31.8	20	M45-2	35	50	39	107
0285N24-52	1.1/2	38.1	24	M52-2	42	60	36	85

0450N

Metric Male 24° Seat Heavy

(CES)

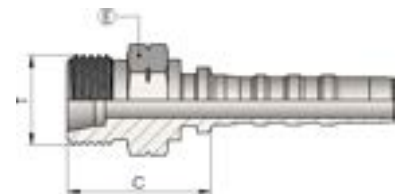

Product number	hose I.D.		Dimension					Cut-off C
	in	mm	dash size	T	erm.	E		
0450N06-20	3/8	9.5	06	M20-1.5	12	22	31	
0450N08-24	1/2	12.7	08	M24-1.5	16	24	33	
0450N10-30	5/8	15.9	10	M30-2	20	30	36	
0450N12-30	3/4	19	12	M30-2	20	30	37	
0450N12-36	3/4	19	12	M36-2	25	36	39	
0450N16-42	1	25.4	16	M42-2	30	46	44	
0450N20-52	1.1/4	31.8	20	M52-2	38	55	48	
0450N24-52	1.1/2	38.1	24	M52-2	38	55	50	

0084N

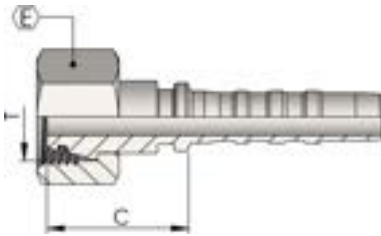

Metric Female 24° Seat Heavy

(DKOS)

Product number	hose I.D.		Dimension				
	in	mm	dash size	T	erm.	E	Cut-off C
0084N06-20	3/8	9.5	06	M20-1.5	12	24	25
0084N08-24	1/2	12.7	08	M24-1.5	16	30	29
0084N10-30	5/8	15.9	10	M30-2	20	34	34
0084N12-30	3/4	19	12	M30-2	20	36	36
0084N12-36	3/4	19	12	M36-2	25	46	41
0084N16-36	1	25.4	16	M36-2	25	46	42
0084N16-42	1	25.4	16	M42-2	30	50	44
0084N20-52	1.1/4	31.8	20	M52-2	38	60	46
0084N24-52	1.1/2	38.1	24	M52-2	38	60	52

0184N

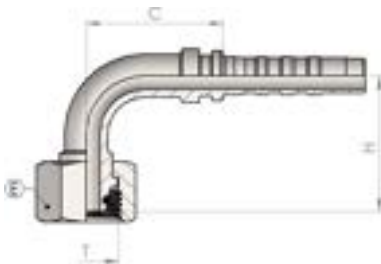

90° Metric Swept Elbow 24° Seat Heavy

(DKOS-90°)

Product number	hose I.D.		Dimension					
	in	mm	dash size	T	erm.	E	drop H	Cut-off C
0184N06-20	3/8	9.5	06	M20-1.5	12	24	34	34
0184N08-24	1/2	12.7	08	M24-1.5	16	30	41	40
0184N10-30	5/8	15.9	10	M30-2	20	36	50	46
0184N12-30	3/4	19	12	M30-2	20	36	56	58
0184N12-36	3/4	19	12	M36-2	25	46	57	59
0184N16-36	1	25.4	16	M36-2	25	46	67	77
0184N16-42	1	25.4	16	M42-2	30	50	67	72
0184N20-52	1.1/4	31.8	20	M52-2	38	60	82	84
0184N24-52	1.1/2	38.1	24	M52-2	38	60	105	105

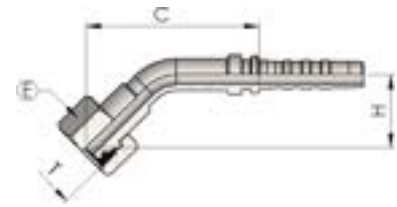
0284N**45° Metric Swept Elbow 24° Seat
Heavy****(DKOS-45°)**

Product number	hose I.D.		Dimension						
	in	mm	dash size	T	erm.	E	drop H	Cut-off C	
0284N06-20	3/8	9.5	06	M20-1.5	12	24	18	53	
0284N08-24	1/2	12.7	08	M24-1.5	16	30	21	63	
0284N10-30	5/8	15.9	10	M30-2	20	36	29	74	
0284N12-30	3/4	19	12	M30-2	20	36	30	90	
0284N12-36	3/4	19	12	M36-2	25	46	29	91	
0284N16-36	1	25.4	16	M36-2	25	46	34	86	
0284N16-42	1	25.4	16	M42-2	30	50	30	87	
0284N20-52	1.1/4	31.8	20	M52-2	38	60	39	105	
0284N24-52	1.1/2	38.1	24	M52-2	38	60	53	129	

S350N

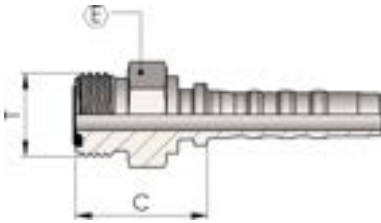

ORFS Male

(AGO)

Product number	hose I.D.		Dimension			
	in	mm	dash size	T	E	Cut-off C
S350N06-09	3/8	9.5	06	11/16-16	19	26
S350N06-11	3/8	9.5	06	13/16-16	22	29
S350N08-11	1/2	12.7	08	13/16-16	22	29
S350N10-13	5/8	15.9	10	1-14	27	33
S350N12-14	3/4	19	12	1.3/16-12	32	36
S350N16-15	1	25.4	16	1.7/16-12	38	37
S350N16-21	1	25.4	16	1.11/16-12	46	38
S350N20-21	1.1/4	31.8	20	1.11/16-12	46	39
S350N20-32	1.1/4	31.8	20	2-12	55	48.5
S350N24-32	1.1/2	38.1	24	2-12	55	52.5

- with plug and O-Ring

S05TN

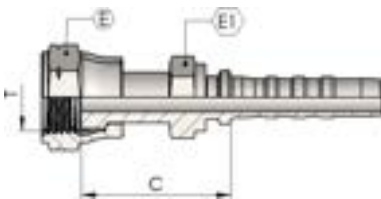

ORFS Female Back Hexagon

(ORFS)

Product number	hose I.D.		Dimension				
	in	mm	dash size	T	E	E1	Cut-off C
S05TN06-09	3/8	9.5	06	11/16-16	22	17	36
S05TN06-11	3/8	9.5	06	13/16-16	24	19	38
S05TN08-11	1/2	12.7	08	13/16-16	24	19	38
S05TN10-13	5/8	15.9	10	1-14	30	24	43
S05TN12-14	3/4	19	12	1.3/16-12	36	30	44
S05TN16-15	1	25.4	16	1.7/16-12	41	36	52
S05TN20-21	1.1/4	31.8	20	1.11/16-12	50	46	56
S05TN24-32	1.1/2	38.1	24	2-12	60	50	62

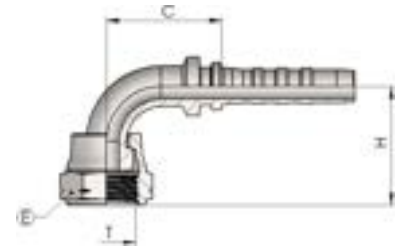
S155N**ORFS 90° Swept Elbow - ISO SHORT****(ORFS-90° S)**

Product number	hose I.D.		Dimension				
	in	mm	dash size	T	E	drop H	Cut-off C
S155N06-09	3/8	9.5	06	11/16-16	22	23	35
S155N08-11	1/2	12.7	08	13/16-16	24	29	44
S155N10-13	5/8	15.9	10	1-14	30	32	47
S155N12-14	3/4	19	12	1.3/16-12	36	48	58

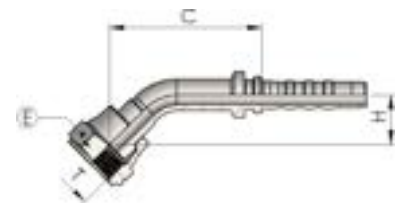
S250N**ORFS 45° Swept Elbow****(ORFS-45°)**

Product number	hose I.D.		Dimension				
	in	mm	dash size	T	E	drop H	Cut-off C
S250N06-09	3/8	9.5	06	11/16-16	22	17	52
S250N06-11	3/8	9.5	06	13/16-16	24	18	51
S250N08-11	1/2	12.7	08	13/16-16	24	20	62
S250N10-13	5/8	15.9	10	1-14	30	22	67
S250N12-14	3/4	19	12	1.3/16-12	36	23	84
S250N16-15	1	25.4	16	1.7/16-12	41	27	82
S250N20-21	1.1/4	31.8	20	1.11/16-12	50	44	104
S250N20-32	1.1/4	31.8	20	2-12	60	44	125
S250N24-32	1.1/2	38.1	24	2-12	60	44	127

S150N

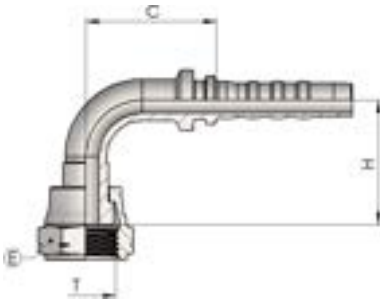

ORFS 90° Swept Elbow

(ORFS-90°)

Product number	hose I.D.		Dimension				
	in	mm	dash size	T	E	drop H	Cut-off C
S150N06-09	3/8	9.5	06	11/16-16	22	33	33
S150N06-11	3/8	9.5	06	13/16-16	24	32	33
S150N08-11	1/2	12.7	08	13/16-16	24	36	43
S150N10-13	5/8	15.9	10	1-14	30	42	46
S150N12-14	3/4	19	12	1.3/16-12	36	49	55
S150N16-15	1	25.4	16	1.7/16-12	41	62	80
S150N16-21	1	25.4	20	1.11/16-12	50	58	62
S150N20-21	1.1/4	31.8	20	1.11/16-12	50	58	96
S150N20-32	1.1/4	31.8	20	2-12	60	73	63
S150N24-32	1.1/2	38.1	24	2-12	60	73	80

1250N

Straight SAE Flange 3000 PSI

(SFL)

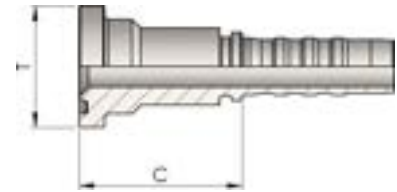

Product number	hose I.D.		Dimension			
	in	mm	dash size	T Flange	mm	Cut-off C
1250N08-08	1/2	12.7	08	1/2	30,2	48
1250N12-12	3/4	19	12	3/4	38.1	54
1250N12-16	3/4	19	12	1	44.5	55
1250N16-16	1	25.4	16	1	44.5	56
1250N16-20	1	25.4	16	1.1/4	50.8	59
1250N20-20	1.1/4	31.8	20	1.1/4	50.8	62
1250N20-24	1.1/4	31.8	20	1.1/2	60.3	65
1250N24-24	1.1/2	38.1	24	1.1/2	60.3	67
1250N24-32	1.1/2	38.1	24	2	71.4	72

1050N

90° SAE Flange 3000 PSI

(SFL 90°)

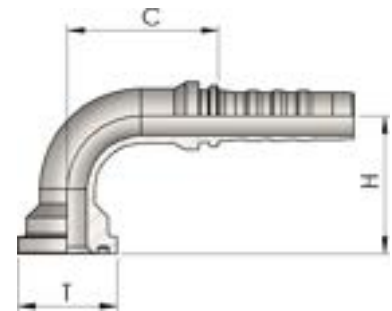

Product number	hose I.D.		Dimension				
	in	mm	dash size	T Flange	mm	drop H	Cut-off C
1050N08-08	1/2	12.7	08	1/2	30,2	39	40
1050N12-12	3/4	19	12	3/4	38.1	53	58
1050N12-16	3/4	19	12	1	44.5	58	58
1050N16-16	1	25.4	16	1	44.5	65	72
1050N16-20	1	25.4	16	1.1/4	50.8	70	72
1050N20-20	1.1/4	31.8	20	1.1/4	50.8	82	97
1050N20-24	1.1/4	31.8	20	1.1/2	60.3	85	96
1050N24-24	1.1/2	38.1	24	1.1/2	60.3	96	115

1150N

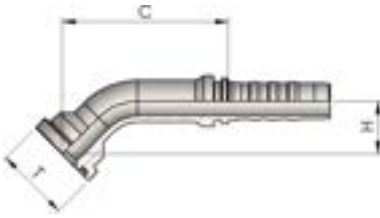

45° SAE Flange 3000 PSI

(SFL 45°)

Product number	hose I.D.		Dimension				
	in	mm	dash size	T Flange	mm	drop H	Cut-off C
1150N12-12	3/4	19	12	3/4	38.1	25	81
1150N12-16	3/4	19	12	1	44.5	28	86
1150N16-16	1	25.4	16	1	44.5	32	79
1150N16-20	1	25.4	16	1.1/4	50.8	37	113
1150N20-20	1.1/4	31.8	20	1.1/4	50.8	39	103
1150N20-24	1.1/4	31.8	20	1.1/2	60.3	39	107
1150N24-24	1.1/2	38.1	24	1.1/2	60.3	44	159

1300N

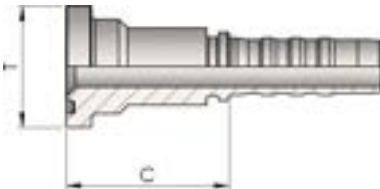

Straight SAE Flange 6000 PSI

(SFS)

Product number	hose I.D.		Dimension			
	in	mm	dash size	T Flange	mm	Cut-off C
1300N08-08	1/2	12.7	08	1/2	31.8	47
1300N12-12	3/4	19	12	3/4	41.3	56
1300N12-16	3/4	19	12	1	47.6	62
1300N16-16	1	25.4	16	1	47.6	63
1300N16-20	1	25.4	16	1.1/4	54	71
1300N20-20	1.1/4	31.8	20	1.1/4	54	73
1300N20-24	1.1/4	31.8	20	1.1/2	63.5	79
1300N24-24	1.1/2	38.1	24	1.1/2	63.5	81
1300N24-32	1.1/2	38.1	24	2	79.4	90

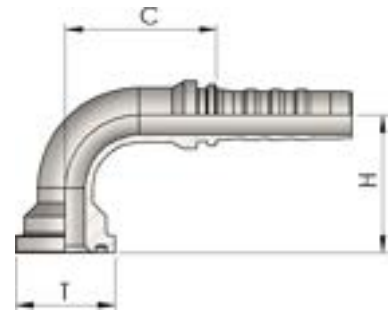
1100N**90° SAE Flange 6000 PSI****(SFS 90°)**

Product number	hose I.D.		Dimension				
	in	mm	dash size	T Flange	mm	drop H	Cut-off C
1100N08-08	1/2	12.7	08	1/2	31.8	39	42
1100N10-12	5/8	15.9	10	3/4	41.3	51	46
1100N12-12	3/4	19	12	3/4	41.3	53	61
1100N12-16	3/4	19	12	1	47.6	63	56
1100N16-16	1	25.4	16	1	47.6	69	72
1100N16-20	1	25.4	16	1.1/4	54	77	72
1100N20-20	1.1/4	31.8	20	1.1/4	54	84.5	100
1100N20-24	1.1/4	31.8	20	1.1/2	63.5	92	99
1100N24-24	1.1/2	38.1	24	1.1/2	63.5	104	127

1200N

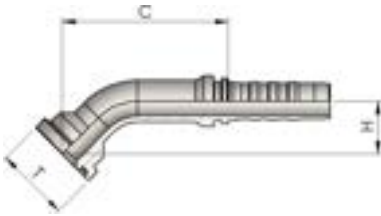

45° SAE Flange 6000 PSI

(SFS 45°)

Product number	hose I.D.		Dimension				
	in	mm	dash size	T Flange	mm	drop H	Cut-off C
1200N08-08	1/2	12.7	08	1/2	31.8	22	62
1200N12-12	3/4	19	12	3/4	41.3	27	90
1200N12-16	3/4	19	12	1	47.6	34	93
1200N16-16	1	25.4	16	1	47.6	34	90
1200N16-20	1	25.4	16	1.1/4	54	40	94
1200N20-16	1.1/4	31.8	20	1	47.6	34	98
1200N20-20	1.1/4	31.8	20	1.1/4	54	41	111
1200N20-24	1.1/4	31.8	20	1.1/2	63.5	46	120
1200N24-20	1.1/2	38.1	24	1.1/4	54	40	154
1200N24-24	1.1/2	38.1	24	1.1/2	63.5	50	122
1200N24-32	1.1/2	38.1	24	2	79.4	59	128

130SN

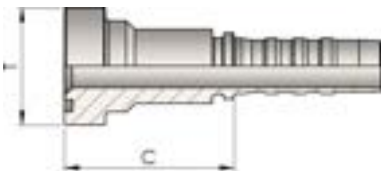

Straight 'CAT' Flange

(SFC)

Product number	hose I.D.		Dimension			
	in	mm	dash size	T Flange	mm	Cut-off C
130SN12-12	3/4	19	12	3/4	41.3	60
130SN12-16	3/4	19	12	1	47.6	66
130SN16-16	1	25.4	16	1	47.6	67
130SN16-20	1	25.4	16	1.1/4	54	75
130SN20-20	1.1/4	31.8	20	1.1/4	54	77
130SN24-24	1.1/2	38.1	24	1.1/2	63.5	85

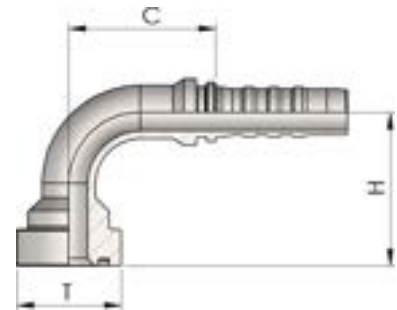
110SN**90° 'CAT' Flange****(SFC 90°)**

Product number	hose I.D.		Dimension				
	in	mm	dash size	T Flange	mm	drop H	Cut-off C
110SN12-12	3/4	19	12	3/4	41.3	62	56
110SN12-16	3/4	19	12	1	47.6	65	56
110SN16-16	1	25.4	16	1	47.6	74	81
110SN16-20	1	25.4	16	1.1/4	54	80	78
110SN20-16	1.1/4	31.8	20	1	47.6	87	97
110SN20-20	1.1/4	31.8	20	1.1/4	54	90	97
110SN20-24	1.1/4	31.8	20	1.1/2	63.5	95	97
110SN24-20	1.1/2	38.1	24	1.1/4	54	101	115
110SN24-24	1.1/2	38.1	24	1.1/2	63.5	104	115
110SN24-32	1.1/2	38.1	24	2	79.4	104	115

120SN

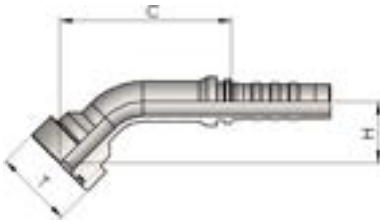

45° 'CAT' Flange

(SFC 45°)

Product number	hose I.D.		Dimension				
	in	mm	dash size	T Flange	mm	drop H	Cut-off C
120SN12-12	3/4	19	12	3/4	41.3	32	88
120SN12-16	3/4	19	12	1	47.6	37	93
120SN16-16	1	25.4	16	1	47.6	37	90
120SN16-20	1	25.4	16	1.1/4	54	44	122
120SN20-16	1.1/4	31.8	20	1	47.6	40	111
120SN20-20	1.1/4	31.8	20	1.1/4	54	43	114
120SN20-24	1.1/4	31.8	20	1.1/2	63.5	48	119
120SN24-20	1.1/2	38.1	24	1.1/4	54	50	170
120SN24-24	1.1/2	38.1	24	1.1/2	63.5	52	172

Interlock Tail





004N



Swaged Ferrule (skive)

117

0042



Swaged Ferrule (skive)

117

0013



Swaged Ferrule (skive)

118

00J4



Swaged Ferrule (skive)

118

00J6



Swaged Ferrule (skive)

119



0370H



NPTF Male 60° cone

119



0350H



BSP Male Parallel 60° cone

120

0050H



BSP Female 60° cone Thrust Wire

120

0150H



BSP 90° Swept Elbow 60° cone Thrust Wire

121

0250H



BSP 45° Swept Elbow 60° Cone - Thrust Wire

121



0850H



JIC Male 74° cone

122

0900H



JIC Female 74° - Thrust Wire Nut

122

0950H



JIC 90° Swept Elbow 74°
Cone - Thrust Wire

123

1000H



JIC 45° Swept Elbow 74°
Cone - Thrust Wire

123



0450H



Metric Male 24° Seat
Heavy

124

0084H



Metric Female 24° Seat
Heavy

124



0184H



90° Metric Swept Elbow
24° Seat Heavy

125

0284H



45° Metric Swept Elbow
24° Seat Heavy

125



S350H



ORFS Male

126

S05TH



ORFS Female Back
Hexagon

126

S150H



ORFS 90° Swept Elbow
Hexagon

127

S250H



ORFS 45° Swept Elbow

127



1250H



Straight SAE Flange
3000 PSI

128

1050H



90° SAE Flange 3000 PSI

128

1150H



45° SAE Flange 3000 PSI

129



1300H



Straight SAE Flange
6000 PSI

130

1100H



90° SAE Flange 6000 PSI

131

1200H



45° SAE Flange 6000 PSI

132



130SH



Straight 'CAT' Flange

132

110SH



90° 'CAT' Flange

133

120SH



45° 'CAT' Flange

133



D050H



Hose Junction

134

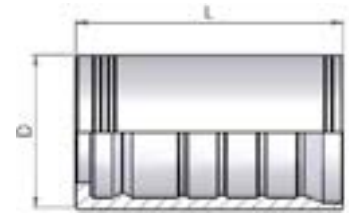
004N**Swaged Ferrule (skive)**

Product number	hose I.D.		Dimension		skive	valid for
	in	mm	D	L	Length	-
004N-12	3/4	19	38	60	52/15	R13-4SH-R15 -(4SP)
004N-16	1	25.4	46	75	64/17	4SH-R13-R15-(4SP)
004N-20	1.1/4	31.8	55	88	74/22	4SH
004N-24	1.1/2	38.1	62	94	81/22,5	4SH
004N-32	2	50.8	78	99	85/30	4SH

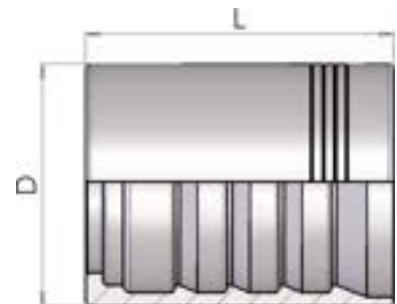
0042**Swaged Ferrule (skive)**

Product number	hose I.D.		Dimension		skive	valid for
	in	mm	D	L	Length	-
0042-20	1.1/4	31.8	60	88	74/22	IS42 - HyTraktion
0042-24	1.1/2	38.1	70	94	82/22	IS42 - HyTraktion

0013

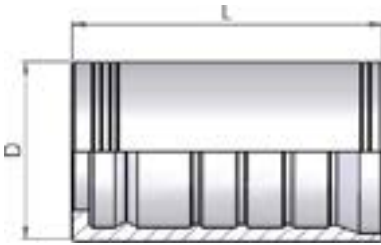

Swaged Ferrule (skive)

Product number	hose I.D.		Dimension		skive	valid for
	in	mm	D	L	Length	-
0013-10	5/8	15.9	34.5	57.5	47/15	R15
0013-16	1	25.4	48	75	64/17	R13-R15
0013-20	1.1/4	31.8	60	88	74/22	R13 -R15
0013-24	1.1/2	38.1	67	94	81/22,5	R13 -R15
0013-32	2	50.8	85	99	85/30	R13-R15
0013-40	2.1/2	63.5	99	140	125/35	R13-R15
0013-48	3	76.2	116	154	135/37	R13-R15

00J4

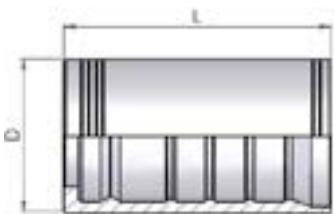

Swaged Ferrule (skive)

Product number	hose I.D.		Dimension		skive	valid for
	in	mm	D	L	Length	-
00J4-16	1	25.4	49	72.5	62/17	HySpir 500

00J6

Swaged Ferrule (skive)

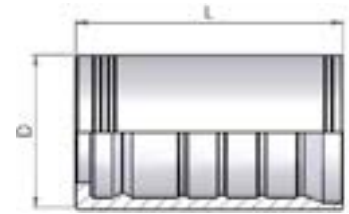

Product number	hose I.D.		Dimension		skive	valid for
	in	mm	D	L	Length	-
00J6-16	1	25.4	51	74.5	65/17	MegaJet

0370H

NPTF Male 60° cone

(AGN)

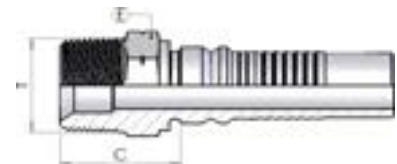

Product number	hose I.D.		Dimension			
	in	mm	dash size	T	E	Cut-off C
0370H12-12	3/4	19	12	3/4-14	27	35
0370H16-16	1	25.4	16	1-11.1/2	36	41
0370H20-20	1.1/4	31.8	20	1.1/4-11.1/2	46	44
0370H24-24	1.1/2	38.1	24	1.1/2-11.1/2	50	47
0370H32-32	2	50.8	32	2-11.1/2	65	54

0350H

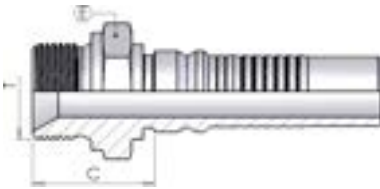

BSP Male Parallel 60° cone

(AGR)

Product number	hose I.D.		Dimension			
	in	mm	dash size	T	E	Cut-off C
0350H12-12	3/4	19	12	3/4-14	32	33
0350H12-16	3/4	19	12	1-11	41	36
0350H16-16	1	25.4	16	1-11	41	37
0350H16-20	1	25.4	16	1.1/4-11	50	41
0350H20-20	1.1/4	31.8	20	1.1/4-11	50	42
0350H24-24	1.1/2	38.1	24	1.1/2-11	55	44
0350H32-32	2	50.8	32	2-11	70	53

0050H

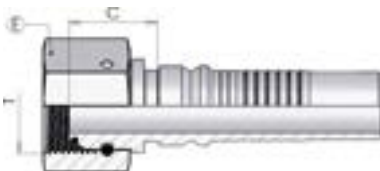

BSP Female 60° cone Thrust Wire

(DKR)

Product number	hose I.D.		Dimension		Note
	in	mm	dash size	Cut-off C	
0050H12-12	3/4	19	12	23	(*)
0050H12-16	3/4	19	12	25	(*)
0050H16-16	1	25.4	16	26	(*)
0050H20-20	1.1/4	31.8	20	29	(*)
0050H20-24	1.1/4	31.8	20	31	(*)
0050H24-24	1.1/2	38.1	24	31	(*)
0050H32-32	2	50.8	32	30	(*)

(*) - BSP O-Ring Female



0150H

BSP 90° Swept Elbow 60° cone Thrust Wire

(DKR 90°)

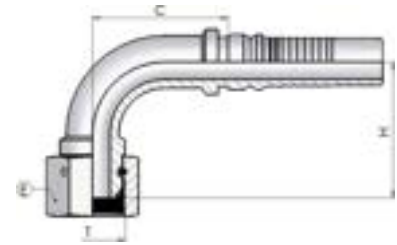

Product number	hose I.D.		Dimension					Note
	in	mm	dash size	T	E	drop H	Cut-off C	
0150H12-12	3/4	19	12	3/4-14	32	60	51	(*)
0150H16-16	1	25.4	16	1-11	41	70	73	(*)
0150H16-20	1	25.4	16	1.1/4-11	50	76	73	(*)
0150H20-20	1.1/4	31.8	20	1.1/4-11	50	83	93	(*)
0150H24-24	1.1/2	38.1	24	1.1/2-11	55	104	110	(*)

(*) - BSP O-Ring Female



0250H

BSP 45° Swept Elbow 60° Cone - Thrust Wire

(DKR 45°)

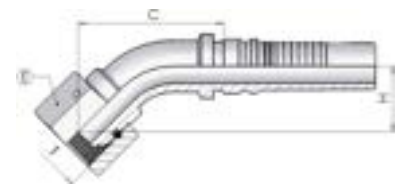

Product number	hose I.D.		Dimension					Note
	in	mm	dash size	T	E	drop H	Cut-off C	
0250H12-12	3/4	19	12	3/4-14	32	31	85	(*)
0250H16-16	1	25.4	16	1-11	41	38	112	(*)
0250H20-20	1.1/4	31.8	20	1.1/4-11	50	41	98	(*)
0250H24-24	1.1/2	38.1	24	1.1/2-11	55	54	166	(*)
0250H32-32	2	50.8	32	2-11	70	71	143	(*)

(*) - BSP O-Ring Female



0850H

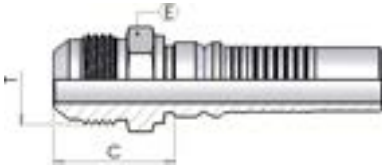

JIC Male 74° cone

(AGJ)

Product number	hose I.D.		Dimension			
	in	mm	dash size	T	E	Cut-off C
0850H12-12	3/4	19	12	1.1/16-12	27	36
0850H16-16	1	25.4	16	1.5/16-12	34	40
0850H20-20	1.1/4	31.8	20	1.5/8-12	42	44
0850H24-24	1.1/2	38.1	24	1.7/8-12	50	49

0900H

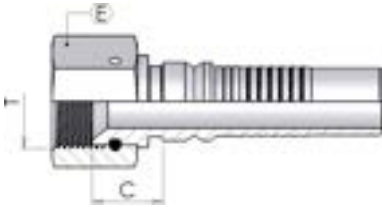

JIC Female 74° - Thrust Wire Nut

(DKJ)

Product number	hose I.D.		Dimension			
	in	mm	dash size	T	E	Cut-off C
0900H12-12	3/4	19	12	1.1/16-12	32	19
0900H12-16	3/4	19	12	1.5/16-12	41	22
0900H16-16	1	25.4	16	1.5/16-12	41	23
0900H20-20	1.1/4	31.8	20	1.5/8-12	50	26
0900H24-24	1.1/2	38.1	24	1.7/8-12	55	29
0900H32-32	2	50.8	32	2.1/2-12	70	30

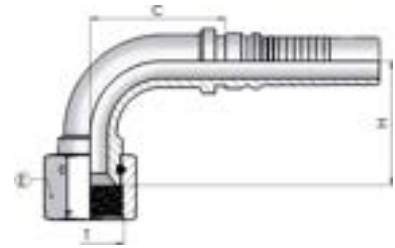
0950H**JIC 90° Swept Elbow 74° Cone -
Thrust Wire****(DKJ 90°)**

Product number	hose I.D.		Dimension				
	in	mm	dash size	Thread T	hex E	drop H	Cut-off C
0950H12-12	3/4	19	12	1.1/16-12	32	59	51
0950H12-16	3/4	19	12	1.5/16-12	41	62	54
0950H16-16	1	25.4	16	1.5/16-12	41	68	74
0950H20-20	1.1/4	31.8	20	1.5/8-12	50	86	92
0950H24-24	1.1/2	38.1	24	1.7/8-12	55	100	112
0950H32-32	2	50.8	32	2.1/2-12	70	134	121

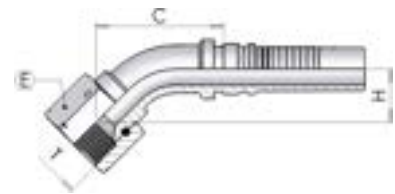
1000H**JIC 45° Swept Elbow 74° Cone -
Thrust Wire****(DKJ 45°)**

Product number	hose I.D.		Dimension				
	in	mm	dash size	T	E	drop H	Cut-off C
1000H12-12	3/4	19	12	1.1/16-12	32	28	85
1000H12-16	3/4	19	12	1.5/16-12	41	32	88
1000H16-16	1	25.4	16	1.5/16-12	41	33	83
1000H20-20	1.1/4	31.8	20	1.5/8-12	50	40	109
1000H24-24	1.1/2	38.1	24	1.7/8-12	55	49	165
1000H32-32	2	50.8	32	2.1/2-12	70	67	194

0450H

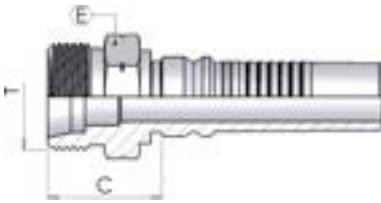

Metric Male 24° Seat Heavy

(CES)

Product number	hose I.D.		Dimension				
	in	mm	dash size	T	erm.	E	Cut-off C
0450H12-36	3/4	19	12	M36-2	25	36	36
0450H16-42	1	25.4	16	M42-2	30	46	39
0450H20-52	1.1/4	31.8	20	M52-2	38	55	42
0450H24-52	1.1/2	38.1	24	M52-2	38	55	42.5

0084H

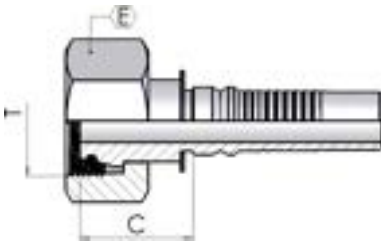

Metric Female 24° Seat Heavy

(DKOS)

Product number	hose I.D.		Dimension				
	in	mm	dash size	T	erm.	E	Cut-off C
0084H12-36	3/4	19	12	M36-2	25	46	37
0084H16-36	1	25.4	16	M36-2	25	46	38
0084H16-42	1	25.4	16	M42-2	30	50	41
0084H20-42	1.1/4	31.8	20	M42-2	30	50	32
0084H20-52	1.1/4	31.8	20	M52-2	38	60	41
0084H24-52	1.1/2	38.1	24	M52-2	38	60	42

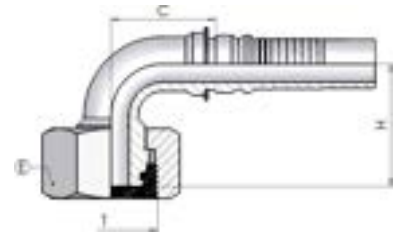
0184H**90° Metric Swept Elbow 24° Seat
Heavy****(DKOS 90°)**

Product number	hose I.D.		Dimension					
	in	mm	dash size	T	erm.	E	drop H	Cut-off C
0184H12-36	3/4	19	12	M36-2	25	46	60	54
0184H16-36	1	25.4	16	M36-2	25	46	68	75
0184H16-42	1	25.4	16	M42-2	30	50	69	74
0184H20-52	1.1/4	31.8	20	M52-2	38	60	83	91

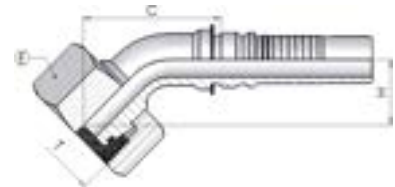
0284H**45° Metric Swept Elbow 24° Seat
Heavy****(DKOS 45°)**

Product number	hose I.D.		Dimension					
	in	mm	dash size	T	erm.	E	drop H	Cut-off C
0284H12-36	3/4	19	12	M36-2	25	46	31	86
0284H16-36	1	25.4	16	M36-2	25	46	34	82
0284H16-42	1	25.4	16	M42-2	30	50	34	83
0284H20-52	1.1/4	31.8	20	M52-2	38	60	40	105

S350H

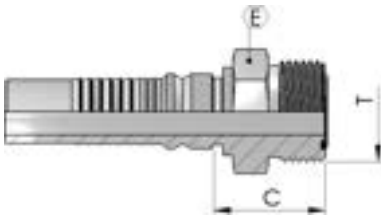

ORFS Male

(AGO)

Product number	hose I.D.		Dimension			
	in	mm	dash size	T	E	Cut-off C
S350H12-14-BO	3/4	19	12	1.3/16-12	32	34
S350H16-15-BO	1	25.4	16	1.7/16-12	38	35
S350H20-21-BO	1.1/4	31.8	20	1.11/16-12	46	36
S350H24-32-BO	1.1/2	38.1	24	2-12	55	38

S05TH

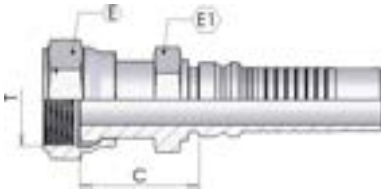

ORFS Female Back Hexagon

(ORFS)

Product number	hose I.D.		Dimension				
	in	mm	dash size	T	E	E1	Cut-off C
S05TH12-14	3/4	19	12	1.3/16-12	30	30	39
S05TH16-15	1	25.4	16	1.7/16-12	36	36	47
S05TH20-21	1.1/4	31.8	20	1.11/16-12	46	46	50

S150H

ORFS 90° Swept Elbow

(ORFS 90°)

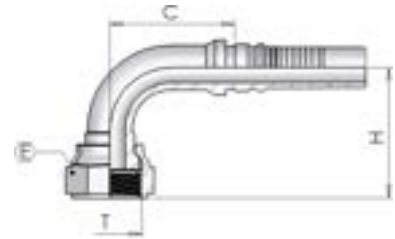

Product number	hose I.D.		Dimension					Note
	in	mm	dash size	T	E	drop H	Cut-off C	
S150H12-14	3/4	19	12	1.3/16-12	36	54	50	
S150H16-15	1	25.4	16	1.7/16-12	41	66	69	
S150H20-21	1.1/4	31.8	20	1.11/16-12	50	80	87	*

* Slip on nut

S250H

ORFS 45° Swept Elbow

(ORFS 45°)

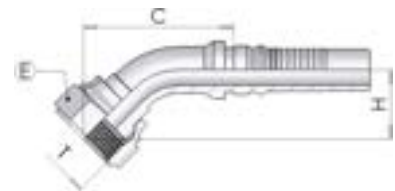

Product number	hose I.D.		Dimension					Note
	in	mm	dash size	T	E	drop H	Cut-off C	
S250H12-14	3/4	19	12	1.3/16-12	36	23	84	
S250H16-15	1	25.4	16	1.7/16-12	41	28	77	
S250H20-21	1.1/4	31.8	20	1.11/16-12	50	37	130	*

* Slip on nut

1250H

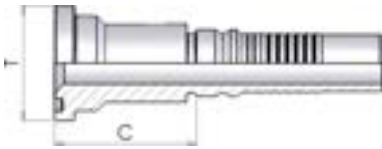

Straight SAE Flange 3000 PSI

(SFL)

Product number	hose I.D.		Dimension			
	in	mm	dash size	T Flange	mm	Cut-off C
1250H12-12	3/4	19	12	3/4	38.1	47
1250H12-16	3/4	19	12	1	44.5	50
1250H16-16	1	25.4	16	1	44.5	52
1250H20-20	1.1/4	31.8	20	1.1/4	50.8	56
1250H20-24	1.1/4	31.8	20	1.1/2	60.3	59
1250H24-24	1.1/2	38.1	24	1.1/2	60.3	60
1250H32-32	2	50.8	32	2	71.4	67

1050H

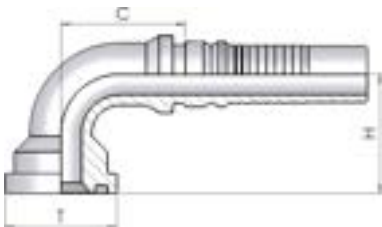

90° SAE Flange 3000 PSI

(SFL 90°)

Product number	hose I.D.		Dimension				
	in	mm	dash size	T Flange	mm	drop H	Cut-off C
1050H12-12	3/4	19	12	3/4	38.1	52	52
1050H12-16	3/4	19	12	1	44.5	56	55
1050H16-16	1	25.4	16	1	44.5	65	73
1050H20-20	1.1/4	31.8	20	1.1/4	50.8	82	91
1050H24-24	1.1/2	38.1	24	1.1/2	60.3	96	106
1050H32-32	2	50.8	32	2	71.4	113	128

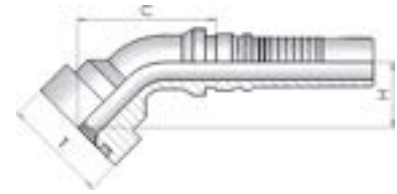
1150H**45° SAE Flange 3000 PSI****(SFL 45°)**

Product number	hose I.D.		Dimension				
	in	mm	dash size	T Flange	mm	drop H	Cut-off C
1150H12-12	3/4	19	12	3/4	38.1	25	81
1150H12-16	3/4	19	12	1	44.5	28	86
1150H16-16	1	25.4	16	1	44.5	35	107
1150H16-20	1	25.4	16	1.1/4	50.8	37	104
1150H20-20	1.1/4	31.8	20	1.1/4	50.8	37	113
1150H20-24	1.1/4	31.8	20	1.1/2	60.3	40	113
1150H24-24	1.1/2	38.1	24	1.1/2	60.3	44	125
1150H24-32	1.1/2	38.1	24	2	71.4	40	126
1150H32-32	2	50.8	32	2	71.4	50	133

1300H

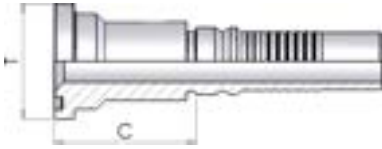

Straight SAE Flange 6000 PSI

(SFS)

Product number	hose I.D.		Dimension			
	in	mm	dash size	T Flange	mm	Cut-off C
1300H12-12	3/4	19	12	3/4	41.3	51
1300H12-16	3/4	19	12	1	47.6	57
1300H16-12	1	25.4	16	3/4	41.3	52
1300H16-16	1	25.4	16	1	47.6	59
1300H16-20	1	25.4	16	1.1/4	54	66
1300H20-16	1.1/4	31.8	20	1	47.6	60
1300H20-20	1.1/4	31.8	20	1.1/4	54	67
1300H20-24	1.1/4	31.8	20	1.1/2	63.5	73
1300H24-20	1.1/2	38.1	24	1.1/4	54	75
1300H24-24	1.1/2	38.1	24	1.1/2	63.5	74
1300H24-32	1.1/2	38.1	24	2	79.4	82
1300H32-32	2	50.8	32	2	79.4	84

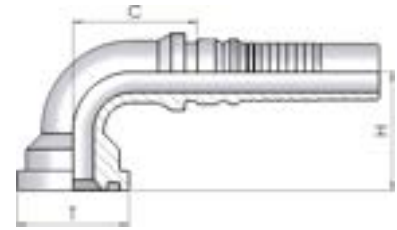
1100H**90° SAE Flange 6000 PSI****(SFS 90°)**

Product number	hose I.D.		Dimension				
	in	mm	dash size	T Flange	mm	drop H	Cut-off C
1100H12-12	3/4	19	12	3/4	41.3	55	53
1100H12-16	3/4	19	12	1	47.6	63	52
1100H16-12	1	25.4	16	3/4	41.3	56	61
1100H16-16	1	25.4	16	1	47.6	69	75
1100H16-20	1	25.4	16	1.1/4	54	74	71
1100H20-16	1.1/4	31.8	20	1	47.6	70	82
1100H20-20	1.1/4	31.8	20	1.1/4	54	84,5	93
1100H20-24	1.1/4	31.8	20	1.1/2	63.5	92	94
1100H24-24	1.1/2	38.1	24	1.1/2	63.5	101	114
1100H24-32	1.1/2	38.1	24	2	79.4	115	115
1100H32-32	2	50.8	32	2	79.4	126	136.5

1200H

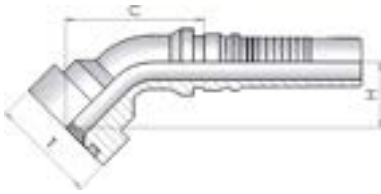

45° SAE Flange 6000 PSI

(SFS 45°)

Product number	hose I.D.		Dimension				
	in	mm	dash size	T Flange	mm	drop H	Cut-off C
1200H12-12	3/4	19	12	3/4	41.3	28	85
1200H12-16	3/4	19	12	1	47.6	34	88
1200H16-12	1	25.4	16	3/4	41.3	31	79
1200H16-16	1	25.4	16	1	47.6	31	85
1200H16-20	1	25.4	16	1.1/4	54	40	89
1200H20-16	1.1/4	31.8	20	1	47.6	38	90
1200H20-20	1.1/4	31.8	20	1.1/4	54	41	109
1200H24-24	1.1/2	38.1	24	1.1/2	63.5	50	133
1200H32-32	2	50.8	32	2	79.4	53	132

130SH

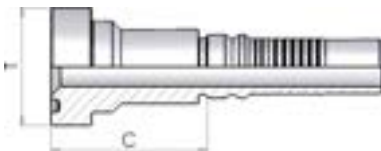

Straight 'CAT' Flange

(SFC)

Product number	hose I.D.		Dimension			
	in	mm	dash size	T Flange	mm	Cut-off C
130SH12-12	3/4	19	12	3/4	41.3	55
130SH12-16	3/4	19	12	1	47.6	62
130SH16-16	1	25.4	16	1	47.6	63
130SH16-20	1	25.4	16	1.1/4	54	70
130SH20-20	1.1/4	31.8	20	1.1/4	54	71
130SH24-24	1.1/2	38.1	24	1.1/2	64	78

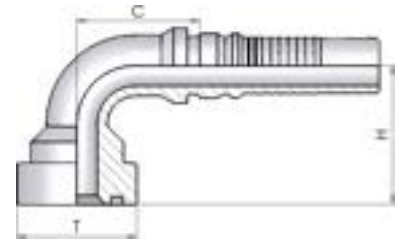
110SH**90° 'CAT' Flange****(SFC 90°)**

Product number	hose I.D.		Dimension				
	in	mm	dash size	T Flange	mm	drop H	Cut-off C
110SH12-12	3/4	19	12	3/4	41.3	62	51
110SH16-16	1	25.4	16	1	47.6	75	73.2
110SH16-20	1	25.4	16	1.1/4	54	82	74
110SH20-20	1.1/4	31.8	20	1.1/4	54	89	93
110SH24-24	1.1/2	38.1	24	1.1/2	63.5	106	110

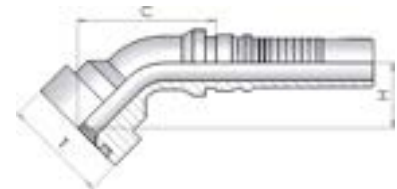
120SH**45° 'CAT' Flange****(SFC 45°)**

Product number	hose I.D.		Dimension				
	in	mm	dash size	T Flange	mm	drop H	Cut-off C
120SH12-12	3/4	19	12	3/4	41.3	30	89
120SH16-16	1	25.4	16	1	47.6	38	86
120SH24-24	1.1/2	38.1	24	1.1/2	63.5	52	169

D050H

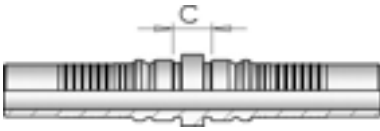

Hose Junction

Product number	hose I.D.		Dimension	
	in	mm	dash size	Cut-off C
D050H12	3/4	19	12	15
D050H16	1	25.4	16	16
D050H20	1.1/4	31.8	20	19
D050H24	1.1/2	38.1	24	19
D050H32	2	50.8	32	24

Hyblast / Multispiral Tail





00Y4



Swaged Ferrule (skive)

138

00Y6



Swaged Ferrule (skive)

138

0019



Swaged Ferrule (skive)

139



0050Y



BSP Female 60° cone Thrust Wire

139



0370Y



NPTF Male 60° cone

140



0084Y



Metric Female 24° Seat Heavy

140



002M



Swaged Ferrule (skive)

141



0900M



JIC Female 74° - Thrust Wire Nut

141

0950M



JIC 90° Swept Elbow 74° Cone - Thrust Wire

142



0050M



BSP Female 60° cone Thrust Wire

142

0150M



BSP 90° Swept Elbow 60° cone Thrust Wire

142



0370M



NPTF Male 60° cone

143



0084M



Metric Female 24° Seat Heavy

143

0184M



90° Metric Swept Elbow 24° Seat Heavy

143

00Y4

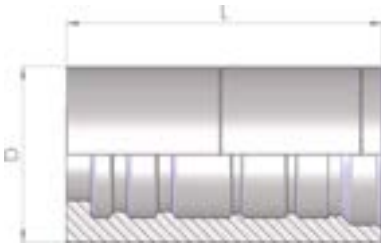

Swaged Ferrule (skive)

Product number	hose I.D.		Dimension		skive	valid for
	in	mm	D	L	Length	-
00Y4-06	3/8	9.5	32.5	58.5	50/22	HB 12k/15k/18k
00Y4-08	1/2	12.7	36.5	62	52/23	HB 12k/15k/18k
00Y4-12	3/4	19	43.8	69	56/25	HB 12k/15k
00Y4-16	1	25.4	51.9	78.5	68/30	HB 10k

00Y6

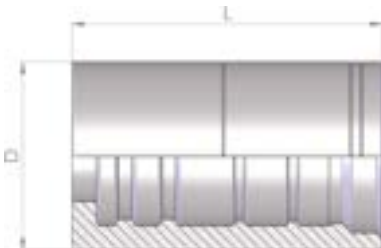

Swaged Ferrule (skive)

Product number	hose I.D.		Dimension		skive	valid for
	in	mm	D	L	Length	-
00Y6-06	3/8	9.5	35.5	58.5	50/22	HB 20k
00Y6-08	1/2	12.7	39.8	62	52/23	HB 20k
00Y6-12	3/4	19	47	69	56/25	HB 20k
00Y6-16	1	25.4	54.9	78.5	68/30	HB 12k

0019

Swaged Ferrule (skive)

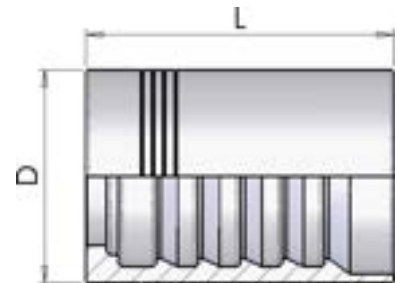

Product number	hose I.D.		Dimension		skive	valid for
	in	mm	D	L	Length	-
0019-04	1/4	6.4	21	40	30	WB-VHP-4SP-4SH

0050Y

BSP Female 60° cone Thrust Wire

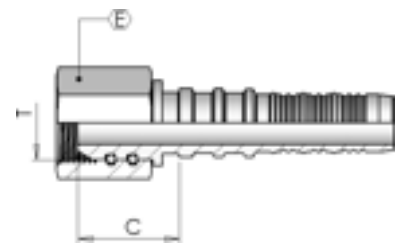

Product number	hose I.D.		Dimension				Max WP
	in	mm	dash size	T	E	Cut-off C	bar
0050Y06-06	3/8	9.5	06	3/8-19	25	28	1250
0050Y08-08	1/2	12.7	08	1/2-14	30	33	1100
0050Y12-12	3/4	19	12	3/4-14	32	33	850
0050Y16-16	1	25.4	16	1-11	38	40	700

0370Y

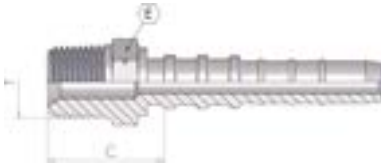

NPTF Male 60° cone

(AGN)

Product number	hose I.D.		Dimension				Max WP
	in	mm	dash size	T	E	Cut-off C	bar
0370Y06-06	3/8	9.5	06	3/8-18	19	29	1100
0370Y08-08	1/2	12.7	08	1/2-14	22	35	1100
0370Y12-12	3/4	19	12	3/4-14	27	37	850
0370Y16-16	1	25.4	16	1-11.1/2	38	49	700

0084Y

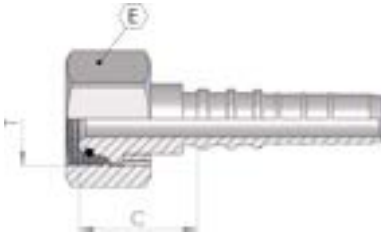

Metric Female 24° Seat Heavy

(DKOS)

Product number	hose I.D.		Dimension					Max WP
	in	mm	dash size	T	erm.	E	Cut-off C	bar
0084Y06-22	3/8	9.5	06	M22-1.5	14	30	38	1450
0084Y06-24	3/8	9.5	06	M24-1.5	16	32	39	1450
0084Y08-24	1/2	12.7	08	M24-1.5	16	34	39	1450
0084Y12-36	3/4	19	12	M36-2	25	46	45	1450

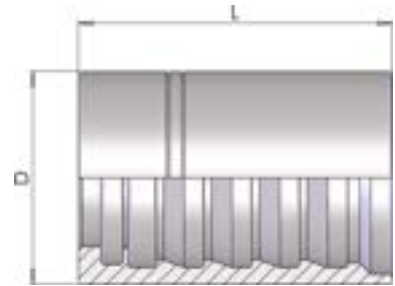
002M**Swaged Ferrule (skive)**

Product number	hose I.D.		Dimension		skive
	in	mm	D	L	Length
002M-04	1/4	6.4	19.6	38	29
002M-06	3/8	9.5	24	40	31

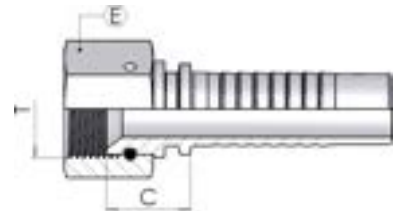
0900M**JIC Female 74° - Thrust Wire Nut****(DKJ)**

Product number	hose I.D.		Dimension			
	in	mm	dash size	T	E	Cut-off C
0900M04-04	1/4	6.4	04	7/16-20	17	16
0900M06-06	3/8	9.5	06	9/16-18	19	18
0900M06-08	3/8	9.5	06	3/4-16	24	20

0950M

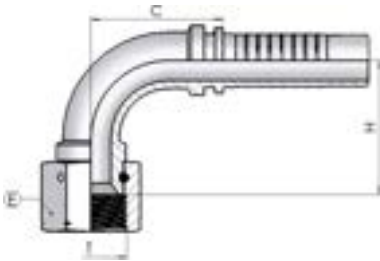

JIC 90° Swept Elbow 74° Cone - Thrust Wire

(DKJ 90°)

Product number	hose I.D.		Dimension				
	in	mm	dash size	T	E	drop H	Cut-off C
0950M04-04	1/4	6.4	04	7/16-20	17	26	26
0950M06-06	3/8	9.5	06	9/16-18	19	33	35
0950M06-08	3/8	9.5	06	3/4-16	24	34	35

0050M

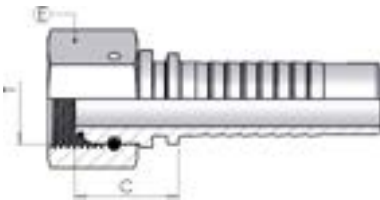

BSP Female 60° cone Thrust Wire

(DKR)

Product number	hose I.D.		Dimension			
	in	mm	dash size	T	E	Cut-off C
0050M04-04	1/4	6.4	04	1/4-19	19	20

0150M

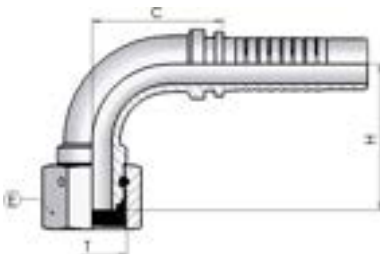

BSP 90° Swept Elbow 60° cone Thrust Wire

(DKR 90°)

Product number	hose I.D.		Dimension				
	in	mm	dash size	T	E	drop H	Cut-off C
0150M04-04	1/4	6.4	04	1/4-19	19	28	26

0370M

NPTF Male 60° cone

(AGN)

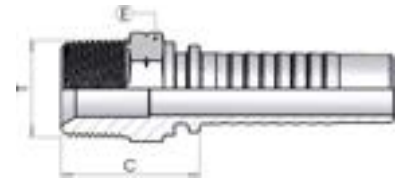

Product number	hose I.D.		Dimension			
	in	mm	dash size	T	E	Cut-off C
0370M04-04	1/4	6.4	04	1/4-18	29	29
0370M06-06	3/8	9.5	06	3/8-19	29	29

0084M

Metric Female 24° Seat Heavy

(DKOS)

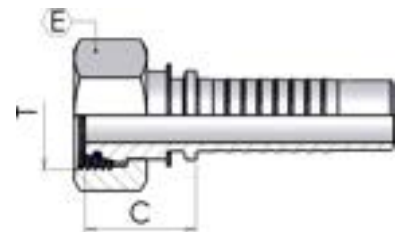

Product number	hose I.D.		Dimension				
	in	mm	dash size	T	erm.	E	Cut-off C
0084M04-16	1/4	6.4	04	M16-1.5	8	19	27
0084M04-18	1/4	6.5	04	M18-1.5	10	22	24

0184M

90° Metric Swept Elbow 24° Seat Heavy

(DKOS 90°)

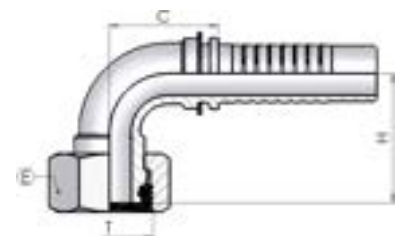

Product number	hose I.D.		Dimension					
	in	mm	dash size	T	erm.	E	drop H	Cut-off C
0184M04-16	1/4	6.4	04	M16-1.5	8	19	26	28
0184M04-18	1/4	6.4	04	M18-1.5	10		31	33

Low Pressure Fittings





P050



BSP Female 60° cone - UniLock

146

P150



BSP 90° Swept elbow 60° cone - UniLock

146



BA



Steel ferrule

147



0345B



BSP Male - Flat Seat

148

0350B



BSP Male Parallel 60° cone

149



0051B



BSP Female 60° Cone

150

0151B



BSP 90° Swept Elbow 60° Cone

151

0251B



BSP 45° Swept Elbow 60° Cone

152



1350B



Metric Banjo

153

P050

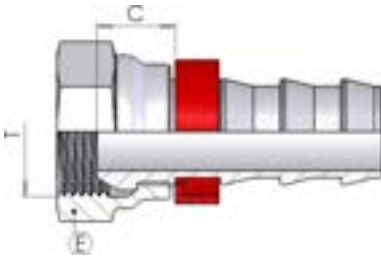

BSP Female 60° cone - UniLock

Product number	hose I.D.		Dimension			
	in	mm	dash size	T	E	Cut-off C
P050-04-04	1/4	6.4	04	1/4-19	17	10
P050-06-06	3/8	9.5	06	3/8-19	19	10
P050-08-08	1/2	12.7	08	1/2-14	27	13
P050-12-12	3/4	19	12	3/4-14	32	16
P050-16-16	1	25.4	16	1-11	38	15

P150

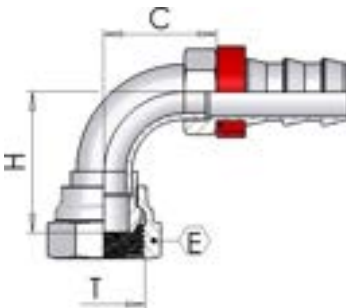

BSP 90° Swept elbow 60° cone - UniLock

Product number	hose I.D.		Dimension				
	in	mm	dash size	T	E	drop H	Cut-off C
P150-04-04	1/4	6.4	04	1/4-19	17	23	21
P150-06-06	3/8	9.5	06	3/8-19	19	29	31
P150-08-08	1/2	12.7	08	1/2-14	27	36	38
P150-12-12	3/4	19	12	3/4-14	32	65	54
P150-16-16	1	25.4	16	1-11	38	55	44

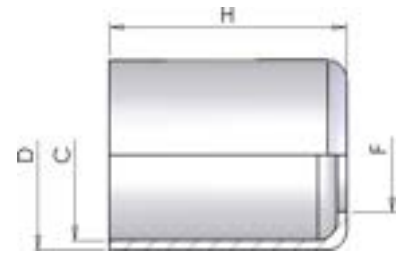
BA**Steel ferrule**

Product number	Dimension			
	D	C	F	H
BA-021-024	24	21	16	31
BA-024-027	27	24	18	31
BA-027-030	30	27	20	34
BA-029-032	32	29	21	35
BA-035-038	38	35	27	36
BA-037-040	40	37	28	38
BA-039-042	42	39	29	40
BA-046-050	50	46	34	46
BA-085-090	90	85	68	63
BA-095-100	100	95	78	68

0345B

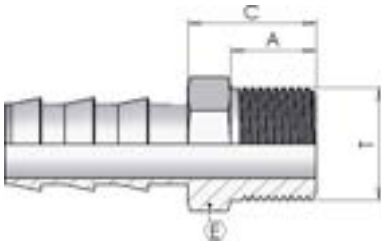

BSP Male - Flat Seat

Product number	hose I.D.		Dimension				
	in	mm	DN	T	A	E	Cut-off C
0345B04-02	1/4	6.4	06	1/8-18	10	14	16
0345B04-04	1/4	6.4	06	1/4-19	10	14	16
0345B05-04	5/16	7.9	08	1/4-19	10	14	16
0345B05-06	5/16	7.9	08	3/8-19	12	17	19
0345B06-04	3/8	9.5	10	1/4-19	10	17	16
0345B06-06	3/8	9.5	10	3/8-19	12	17	19
0345B06-08	3/8	9.5	10	1/2-14	13	22	21
0345B08-06	1/2	12.7	13	3/8-19	12	19	19
0345B08-08	1/2	12.7	13	1/2-14	13	22	21
0345B10-06	5/8	15.9	16	3/8-19	12	19	19
0345B10-08	5/8	15.9	16	1/2-14	13	22	21
0345B10-12	5/8	15.9	16	3/4-14	15	27	21
0345B12-08	3/4	19	19	1/2-14	13	24	21
0345B12-12	3/4	19	19	3/4-14	15	27	23
0345B12-16	3/4	19	19	1-11	16	34	25
0345B16-12	1	25.4	25	3/4-14	15	30	23
0345B16-16	1	25.4	25	1-11	16	34	25
0345B20-12	1.1/4	31.8	32	3/4-14	15	34	23
0345B20-16	1.1/4	31.8	32	1-11	16	36	26
0345B20-20	1.1/4	31.8	32	1.1/4-11	17	42	27
0345B24-20	1.1/2	38.1	38	1.1/4-11	17	42	27
0345B24-24	1.1/2	38.1	38	1.1/2-11	18	50	29
0345B32-32	2	50.8	50	2-11	19	60	31
0345B40-40	2.1/2	63.5	70	2.1/2-11	23	75	36

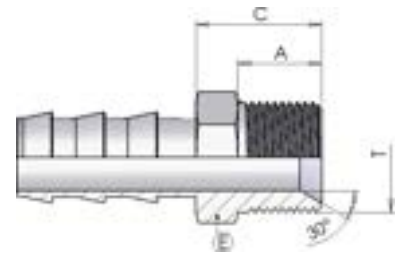
0350B**BSP Male Parallel 60° cone**

Product number	hose I.D.		Dimension				
	in	mm	DN	T	A	E	Cut-off C
0350B04-02	1/4	6.4	06	1/8-28	9	14	14
0350B04-04	1/4	6.4	06	1/4-19	10	19	16
0350B05-04	5/16	7.9	08	1/4-19	10	19	16
0350B06-04	3/8	9.5	10	1/4-19	10	19	16
0350B06-06	3/8	9.5	10	3/8-19	12	22	18

0051B

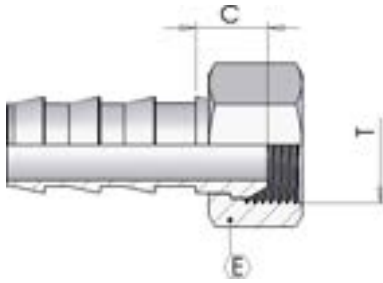

BSP Female 60° Cone

Product number	hose I.D.		Dimension			
	in	mm	DN	T	E	Cut-off C
0051B03-02	3/16	4.8	05	1/8-28	14	9
0051B04-02	1/4	6.4	06	1/8-28	14	9
0051B04-04	1/4	6.4	06	1/4-19	17	10
0051B05-04	5/16	7.9	08	1/4-19	17	10
0051B05-06	5/16	7.9	08	3/8-19	19	11
0051B06-06	3/8	9.5	10	3/8-19	19	11
0051B06-08	3/8	9.5	10	1/2-14	24	12
0051B08-06	1/2	12.7	13	3/8-19	19	11
0051B08-08	1/2	12.7	13	1/2-14	24	12
0051B10-08	5/8	15.9	16	1/2-14	24	12
0051B10-12	5/8	15.9	16	3/4-14	30	14
0051B12-12	3/4	19	19	3/4-14	30	14
0051B12-16	3/4	19	19	1-11	38	15
0051B16-16	1	25.4	25	1-11	38	16
0051B20-20	1.1/4	31.8	32	1.1/4-11	46	16
0051B20-24	1.1/4	31.8	32	1.1/2-11	55	18
0051B24-24	1.1/2	38.1	38	1.1/2-11	55	18
0051B32-32	2	50.8	50	2-11	65	19
0051B40-40	2.1/2	63.5	60	2.1/2-11	85	24
0051B48-48	3	76.2	70	3-11	100	26

0151B

BSP 90° Swept Elbow 60° Cone

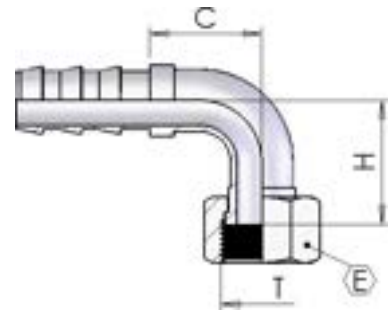

Product number	hose I.D.		Dimension				
	in	mm	DN	T	E	drop H	Cut-off C
0151B04-04	1/4	6.4	06	1/4-19	17	25	28
0151B05-04	5/16	7.9	08	1/4-19	17	25	28
0151B05-06	5/16	7.9	08	3/8-19	19	32	32
0151B06-06	3/8	9.5	10	3/8-19	19	33	33
0151B06-08	3/8	9.5	10	1/2-14	24	35	38
0151B08-06	1/2	12.7	13	3/8-19	19	35	38
0151B08-08	1/2	12.7	13	1/2-14	24	41	43
0151B08-12	1/2	12.7	13	3/4-14	30	45	40
0151B10-08	5/8	15.9	16	1/2-14	24	41	44
0151B10-12	5/8	15.9	16	3/4-14	30	45	40
0151B12-12	3/4	19	19	3/4-14	30	49	51
0151B12-16	3/4	19	19	1-11	38	49	45
0151B16-12	1	25.4	25	3/4-14	32	57	45
0151B16-16	1	25.4	25	1-11	38	58	60
0151B16-20	1	25.4	25	1.1/4-11	46	64	56
0151B20-20	1.1/4	31.8	32	1.1/4-11	46	66	70
0151B24-24	1.1/2	38.1	38	1.1/2-11	55	75	70
0151B32-32	2	50.8	50	2-11	65	70	66
0151B40-40	2.1/2	63.5	60	2.1/2-11	85	85	82

0251B

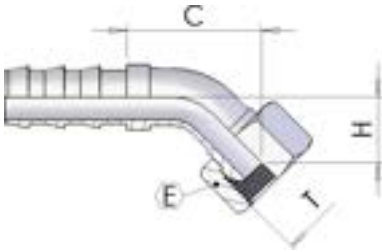

BSP 45° Swept Elbow 60° Cone

Product number	hose I.D.		Dimension				
	in	mm	DN	T	E	drop H	Cut-off C
0251B04-04	1/4	6.4	06	1/4-19	17	17	44
0251B05-06	5/16	7.9	08	3/8-19	19	19	50
0251B06-06	3/8	9.5	10	3/8-19	19	20	52
0251B06-08	3/8	9.5	10	1/2-14	24	23	54
0251B08-06	1/2	12.7	13	3/8-19	19	23	54
0251B08-08	1/2	12.7	13	1/2-14	24	25	60
0251B10-12	5/8	15.9	16	3/4-14	30	28	65
0251B12-12	3/4	19	19	3/4-14	30	28	65
0251B12-16	3/4	19	19	1-11	38	30	55
0251B16-16	1	25.4	25	1-11	38	30	74
0251B20-20	1.1/4	31.8	32	1.1/4-11	46	35	72
0251B24-24	1.1/2	38.1	38	1.1/2-11	55	35	72
0251B32-32	2	50.8	50	2-11	65	50	90

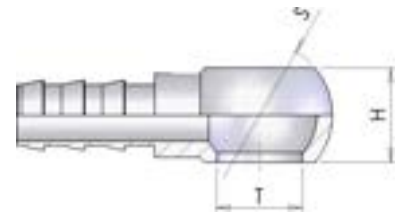
1350B**Metric Banjo**

Product number	hose I.D.		Dimension			
	in	mm	DN	hole T	H	S
1350B04-10	1/4	6.4	06	M10-1	11	17
1350B04-12	1/4	6.4	06	M12-1,5	12	20
1350B04-14	1/4	6.4	06	M14-1,5	14	24
1350B05-12	5/16	7.9	08	M12-1,5	12	20
1350B05-14	5/16	7.9	08	M14-1,5	14	24
1350B05-16	5/16	7.9	08	M16-1,5	19	28
1350B06-16	3/8	9.5	10	M16-1,5	19	28
1350B06-18	3/8	9.5	10	M18-1,5	20	32
1350B08-18	1/2	12.7	13	M18-1,5	20	32
1350B08-22	1/2	12.7	13	M22-1,5	23	36
1350B10-18	5/8	15.9	16	M18-1,5	20	32

Analytic Index

0001	14	0250N 0251N	94
0002	15	0251	28
0003	19	0251B	152
0007	18	0258	28
0008	19	0284	50
0009	16	0284H	125
0013	118	0284N	103
0019	139	0285	46
001C	11	0285N	101
001L	11	0345	21
0022	12	0345B	148
002M	141	0350	23
0030	78	0350B	149
0035	54	0350H	120
0041	30	0350N	91
0042	117	035G	24
0048	30	0360	33
004H	16	0370	34
004N	117	0370H	119
0050	25	0370M	143
0050H	120	0370N	91
0050M	142	0370Y	140
0050N 0051N	92	037G	35
0050Y	139	0385	42
0051	25	0400	56
0051B	150	0450	47
0051D	26	0450H	124
0058	25	0450N	101
0060	22	0500	43
0084	48	0500N	99
0084H	124	0550	51
0084M	143	0650	52
0084N	102	0650S	52
0084Y	140	0750	53
0085	44	0750S	53
0085N	100	0850	36
00J4	118	0850H	122
00J6	119	0850N	95
00Y4	138	0900	37
00Y6	138	0900H	122
0100	57	0900M	141
012N	13	0900N 0901N	96
0135	55	0901	37
0141	31	0901D	38
0148	31	0902	37
0150	27	0920	77
0150H	121	0930	76
0150M	142	0940	75
0150N 0151N	93	0950	39
0151	27	0950H	123
0151B	151	0950M	142
0158	27	0950N 0951N	97
0184	49	0951	39
0184H	125	0952	39
0184M	143	0955	41
0184N	102	0955N	97
0185	45	0980S	77
0185N	100	0990S	76
0200	58	0NI4	90
0241	32	0NI6	90
0248	32	0S14	17
0250	28	1000	40
0250H	121	1000H	123

Analytic Index

1000N 1001N	98	S05TN	104
1001	40	S150	62
1002	40	S150H	127
1050	74	S150N	106
1050H	128	S15S	63
1050N	107	S15SN	105
1060	66	S250	64
1100H	131	S250H	127
1100N	109	S250N	105
110S	73	S350	59
110SH	133	S350H	126
110SN	111	S350N	104
1110	70		
1150	74		
1150H	129		
1150N	108		
1160	67		
1200H	132		
1200N	110		
120S	73		
120SH	133		
120SN	112		
1210	71		
1250	74		
1250H	128		
1250N	107		
1260	65		
1300H	130		
1300N	108		
130S	72		
130SH	132		
130SN	110		
1310	69		
1350	82		
1350B	153		
1400	80		
1600	81		
1600-00	81		
1650	83		
2300	29		
2321	29		
2971	41		
BA	147		
BMC1	17		
BMC2	18		
D050	84		
D050H	134		
FK50	78		
FN50	79		
FN51	79		
FS3L	67		
FS6L	71		
GS00	85		
N051	35		
P050	146		
P150	146		
PTFE	20		
PTFE-C	20		
S003	68		
S006	72		
S050	60		
S05T	61		
S05TH	126		

Sections Index

Standard Tail	1	90° Metric Swept Elbow 24° Seat Heavy	49
Swaged Ferrule (no skive)	11	45° Metric Swept Elbow 24° Seat Heavy	50
Swaged Ferrule (no skive)	11	Metric Standpipe	51
Swaged Ferrule (no skive)	12	90° Metric Standpipe	52
Swaged Ferrule	13	Female Metric Tubular 90° (welded)	52
Swaged Ferrule (skive)	14	45° Metric Standpipe	53
Swaged Ferrule (skive)	15	45° Metric Standpipe (welded)	53
Swaged Ferrule (skive)	16	Metric Female 24° Seat Light Multiseal	54
Swaged Ferrule (skive)	16	90° Metric Swept Elbow 24° Seat Light Multiseal	55
Swaged Ferrule (skive)	17	Metric Male 60° cone	56
Swaged Ferrule (no skive)	17	Metric Female 60° cone	57
Swaged Ferrule (no skive)	18	90° Metric Swept Elbow 60° cone	58
Swaged Ferrule (no skive)	18	ORFS Male	59
Swaged Ferrule (no skive)	19	ORFS Female	60
Swaged Ferrule (no skive)	19	ORFS Female Back Hexagon	61
Ferrule for PTFE hose	20	ORFS 90° Swept Elbow	62
Ferrule for PTFE hose	20	ORFS 90° Swept Elbow - ISO SHORT	63
BSP Male - Flat Seat	21	ORFS 45° Swept Elbow	64
BSP Female flat seat	22	Straight SAE Flange 3000 PSI	65
BSP Male Parallel 60° cone	23	90° SAE Flange 3000 PSI	66
BSP Male Parallel 60° Cone - Rotating	24	45° SAE Flange 3000 PSI	67
BSP Female 60° Cone	25	90° SAE Flange 3000 Psi - Long Drop	67
BSP Female 60° Cone - Rolled Nut	25	Cut Split Flanges - 3000 psi	68
BSP Female 60° Cone Slip On Nut	25	Straight SAE Flange 6000 PSI	69
BSP Female 60° Cone - Double Hexagon	26	90° SAE Flange 6000 PSI	70
BSP 90° Swept elbow 60° cone	27	45° SAE Flange 6000 PSI	71
BSP 90° Swept Elbow 60° Cone - Rolled Nut	27	90° SAE Flange 6000 PSI - Long Drop	71
BSP 90° Swept elbow 60° cone Slip On Nut	27	Cut Split Flanges - 6000 psi	72
BSP 45° Swept Elbow 60° Cone	28	Straight 'CAT' Flange	72
BSP 45° Swept Elbow 60° Cone - Rolled nut	28	90° 'CAT' Flange	73
BSP 45° Swept Elbow 60° Cone - Slipse on nut	28	45° 'CAT' Flange	73
BSP 90° Compact Elbow 60° Cone	29	Flangia Komatsu dritta SAE 3000 PSI	74
BSP 90° Compact Elbow 60° Cone - Thrust wire - Wel	29	Komatsu Flange 90°	74
BSP O'Ring Female 60° Cone	30	Flangia Komatsu 45° SAE 3000 PSI	74
BSP O'Ring Female 60° Cone - Slip on nut	30	JIS Female 60° Cone (Komatsu)	75
BSP O'Ring 90° Swept elbow 60° cone	31	90° JIS Swept Elbow (Komatsu) - welded	76
BSP O'Ring 90° Swept elbow 60° cone- Slip on nut	31	JIS Female 60° cone (Toyota)	76
BSP O'Ring 45° Swept Elbow 60° Cone	32	90° JIS Swept Elbow (Toyota) - welded	77
BSP O'Ring 45° Swept Elbow 60° Cone - Slip on nut	32	JIS Female 60° cone (Nissan)	77
BSP Taper Male 60° cone	33	Metric Female 24° Cone French Type	78
NPTF Male 60° cone	34	K' Female	78
NPTF Male Parallel 60° Cone - Rotating	35	'K' Male (for gun) - Diameter 10	79
NPSM Female 60° Cone Rolled Nut	35	'K' Male (for gun) - Diameter 11	79
JIC Male 74° cone	36	BSP Banjo	80
JIC Female 74°	37	Double BSP Perfored Bolt	81
JIC Female 74° cone - Rolled Nut	37	BSP Perfored Bolt	81
JIC Female 74° - Slip on nut	37	Metric Banjo	82
JIC Female 74° Cone- Double Hexagon	38	Metric perfored bolt	83
JIC 90° Swept Elbow 74° cone	39	Hose Junction	84
JIC 90° Swept Elbow 74° cone - Rolled Nut	39	Weldable Fitting	85
JIC 90° Swept Elbow 74° cone - Slip on nut	39	N Tail	86
JIC 45° Swept Elbow 74°	40	Swaged Ferrule 4WS (no skive)	90
JIC 45° Swept Elbow 74° cone - Rolled Nut	40	Swaged Ferrule (no skive)	90
JIC 45° Swept Elbow 74° Cone Slipse on nut	40	NPTF Male 60° cone	91
JIC 90° Swept Elbow 74° cone - ISO SHORT	41	BSP Male Parallel 60° cone	91
JIC 90° Compact Elbow 74° cone - Crimped Nut	41	BSP Female 60° Cone	92
SAE Male O'R Flat Seat	42	BSP 90° Swept elbow 60° cone	93
Metric Male 24° Seat Light	43	BSP 45° Swept Elbow 60° Cone	94
Metric Female 24° Seat Light	44	JIC Male 74° cone	95
90° Metric Swept Elbow 24° Seat Light	45	JIC Female 74° Cone- Double Hexagon	96
45° Metric Swept Elbow 24° Seat Light	46	JIC 90° Swept Elbow 74° cone	97
Metric Male 24° Seat Heavy	47	JIC 90° Swept Elbow 74° cone - ISO SHORT	97
Metric Female 24° Seat Heavy	48	JIC 45° Swept Elbow 74°	98

Sections Index

Metric Male 24° Seat Light	99	JIC Female 74° - Thrust Wire Nut	141
Metric Female 24° Seat Light	100	JIC 90° Swept Elbow 74° Cone - Thrust Wire	142
90° Metric Swept Elbow 24° Seat Light	100	BSP Female 60° cone Thrust Wire	142
45° Metric Swept Elbow 24° Seat Light	101	BSP 90° Swept Elbow 60° cone Thrust Wire	142
Metric Male 24° Seat Heavy	101	NPTF Male 60° cone	143
Metric Female 24° Seat Heavy	102	Metric Female 24° Seat Heavy	143
90° Metric Swept Elbow 24° Seat Heavy	102	90° Metric Swept Elbow 24° Seat Heavy	143
45° Metric Swept Elbow 24° Seat Heavy	103	Low Pressure Fittings	144
ORFS Male	104	BSP Female 60° cone - UniLock	146
ORFS Female Back Hexagon	104	BSP 90° Swept elbow 60° cone - UniLock	146
ORFS 90° Swept Elbow - ISO SHORT	105	Steel ferrule	147
ORFS 45° Swept Elbow	105	BSP Male - Flat Seat	148
ORFS 90° Swept Elbow	106	BSP Male Parallel 60° cone	149
Straight SAE Flange 3000 PSI	107	BSP Female 60° Cone	150
90° SAE Flange 3000 PSI	107	BSP 90° Swept Elbow 60° Cone	151
45° SAE Flange 3000 PSI	108	BSP 45° Swept Elbow 60° Cone	152
Straight SAE Flange 6000 PSI	108	Metric Banjo	153
90° SAE Flange 6000 PSI	109		
45° SAE Flange 6000 PSI	110		
Straight 'CAT' Flange	110		
90° 'CAT' Flange	111		
45° 'CAT' Flange	112		
Interlock Tail	113		
Swaged Ferrule (skive)	117		
Swaged Ferrule (skive)	117		
Swaged Ferrule (skive)	118		
Swaged Ferrule (skive)	118		
Swaged Ferrule (skive)	119		
NPTF Male 60° cone	119		
BSP Male Parallel 60° cone	120		
BSP Female 60° cone Thrust Wire	120		
BSP 90° Swept Elbow 60° cone Thrust Wire	121		
BSP 45° Swept Elbow 60° Cone - Thrust Wire	121		
JIC Male 74° cone	122		
JIC Female 74° - Thrust Wire Nut	122		
JIC 90° Swept Elbow 74° Cone - Thrust Wire	123		
JIC 45° Swept Elbow 74° Cone - Thrust Wire	123		
Metric Male 24° Seat Heavy	124		
Metric Female 24° Seat Heavy	124		
90° Metric Swept Elbow 24° Seat Heavy	125		
45° Metric Swept Elbow 24° Seat Heavy	125		
ORFS Male	126		
ORFS Female Back Hexagon	126		
ORFS 90° Swept Elbow	127		
ORFS 45° Swept Elbow	127		
Straight SAE Flange 3000 PSI	128		
90° SAE Flange 3000 PSI	128		
45° SAE Flange 3000 PSI	129		
Straight SAE Flange 6000 PSI	130		
90° SAE Flange 6000 PSI	131		
45° SAE Flange 6000 PSI	132		
Straight 'CAT' Flange	132		
90° 'CAT' Flange	133		
45° 'CAT' Flange	133		
Hose Junction	134		
Hyblast / Multispiral Tail	135		
Swaged Ferrule (skive)	138		
Swaged Ferrule (skive)	138		
Swaged Ferrule (skive)	139		
BSP Female 60° cone Thrust Wire	139		
NPTF Male 60° cone	140		
Metric Female 24° Seat Heavy	140		
Swaged Ferrule (skive)	141		



INTERPUMP

FLUID SOLUTIONS 

Powered by I.M.M. Hydraulics



I.M.M. Hydraulics Spa
interpumpfluidsolutions.com

Via Italia, 49-51
66041 - Atessa (Ch) - Italy
T. +39 (0) 0872 889225
F. +39 (0) 0872 889226



CAT-IFS-C-EN